



Infant Car Seat Adapter Instructions

Congratulations on your purchase of the BOB Infant Car Seat Adapter (ICSA). It is designed to allow the attachment of an Infant Car Seat to your BOB Stroller. Please refer to the tables at right for details of compatible strollers and car seats.

Car Seat Compatibility		
Brand	Model	Year (s)
Britax	Companion™	2003-2008
Graco®	Snug Ride®	2003 and newer
Graco®	Snug Ride® 30	2010 and newer
Graco®	Snug Ride® 32	2008 and newer
Graco®	Snug Ride® 35	2009 and newer
Graco®	Safe Seat™	2006 and newer
Peg Perego®	Primo Viaggio™	2003 and newer
Peg Perego®	Primo Viaggio SIP™	2006 and newer
Peg Perego®	Primo Viaggio SIP™ 30/30	2007 and newer

BOB® Stroller Compatibility	
Model	Serial Number Range
Sport Utility Stroller	AA000001 - AA999999
Sport utility Stroller D'Lux	AB000001 - AB999999
Ironman®	AC000001 - AC999999
Revolution®	AF000001 - AF999999
Stroller Strides®	AG000001 - AG999999
Revolution 12"	AK000001 - AK999999

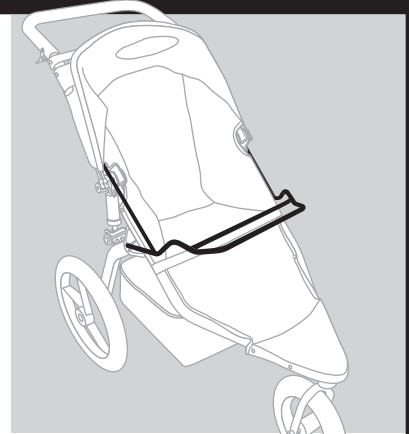

! WARNING

This product is compatible with strollers that have a serial number within the range listed. Using this product on strollers with incompatible serial numbers may lead to injury or death.

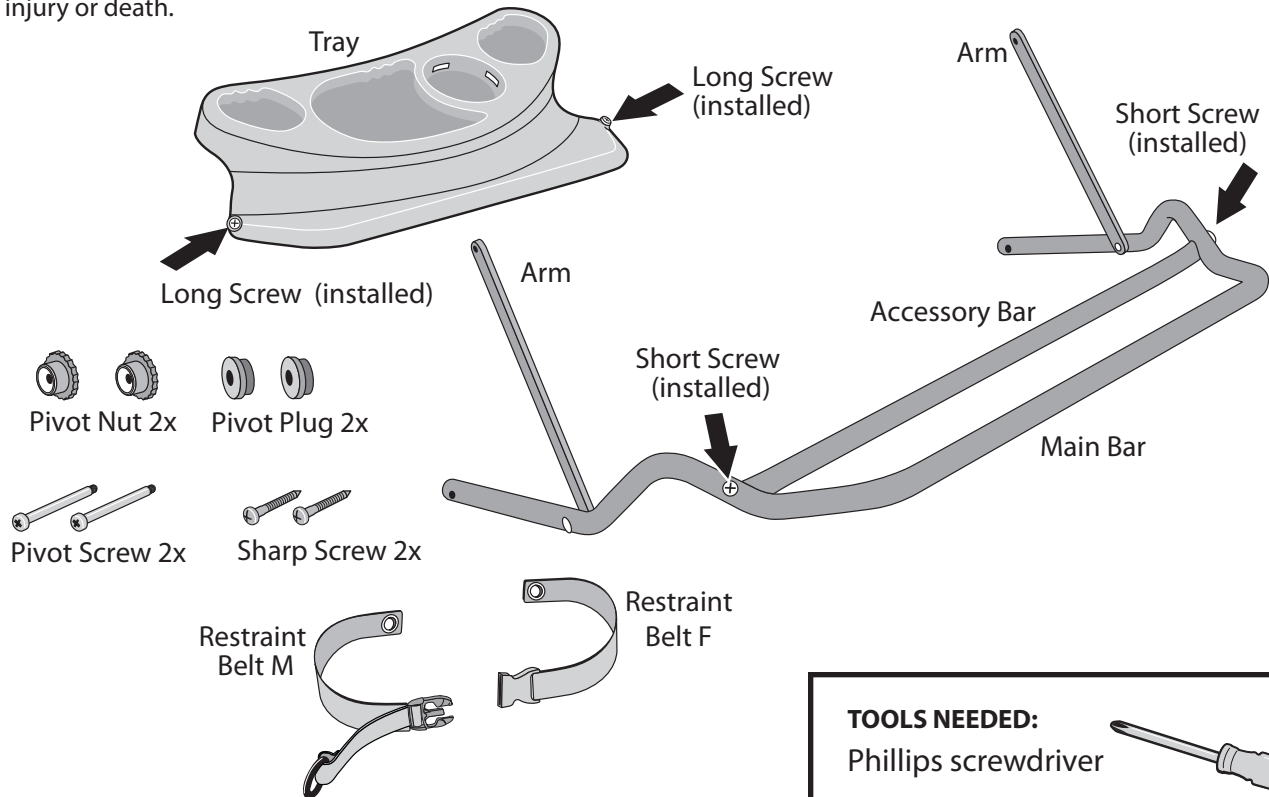

TAKE TIME - READ AND UNDERSTAND INSTRUCTIONS COMPLETELY!

Before attempting to assemble or use your new ICSA, read and understand these assembly instructions completely, as well as the warnings at the end of this document, to insure proper assembly and safe operation.

If you are unclear on any point, contact your dealer or BOB before use.

ATTACH MAIN BAR

1 SET PARKING BRAKE. See the "Parking Brake" section of your stroller owner's manual.

2 POSITION ARMS

Rotate **arms** into an upright position.

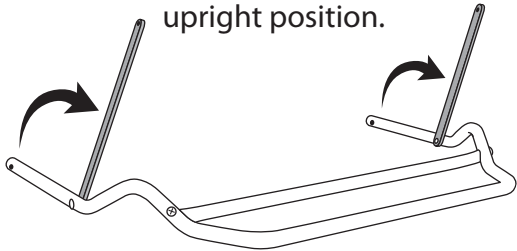

3 ASSEMBLE SCREW, PLUG AND BAR

Insert one **pivot screw** through one end of **main bar** and into **pivot plug**.

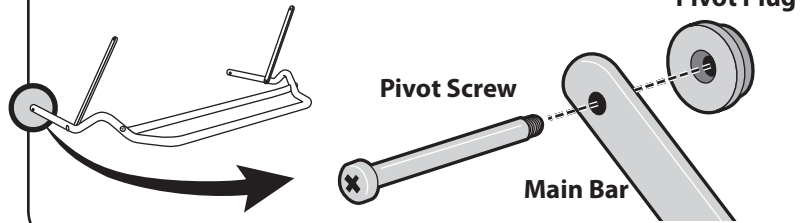

4 POSITION ICSA

Holding **pivot screw** and **pivot plug** in place with hand, position ends of **main bar** over pivot brackets.

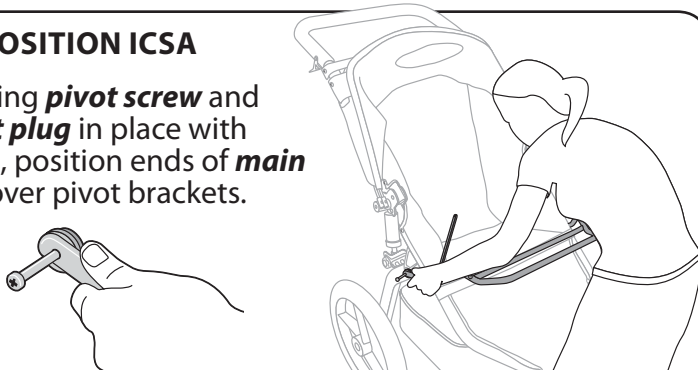

5 INSERT PIVOT PLUG AND SCREW

Slip **pivot plug** into opening on pivot bracket and push **pivot screw** flush against **bar**.

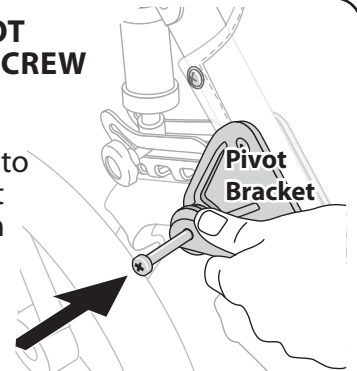

6 INSERT PIVOT PLUG ON OPPOSITE SIDE

Slip **pivot plug** under end of **main bar** and into opening on pivot bracket.

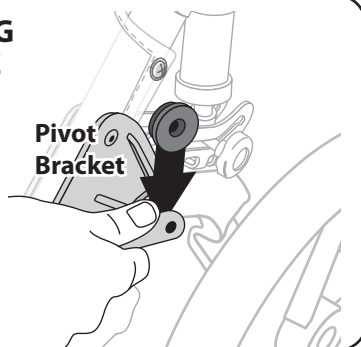

7 INSERT PIVOT SCREW

Insert **pivot screw** through **main bar**, **pivot plug** and into opening on pivot bracket.

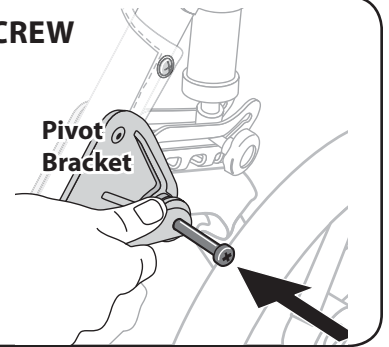

8 INSTALL PIVOT NUT

Reach under fabric seat. Thread **pivot nut** onto **pivot screw** as shown.

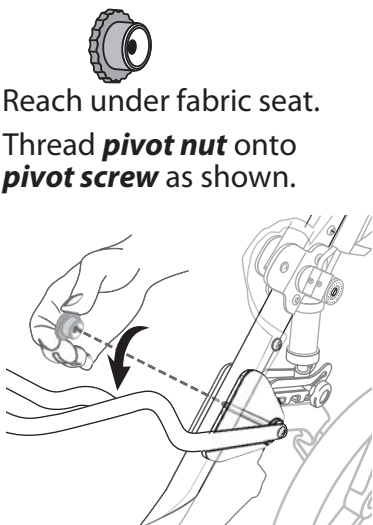

9 TIGHTEN PIVOT NUT

Use a Phillips screwdriver to tighten **pivot screw** clockwise, while holding **pivot nut**.

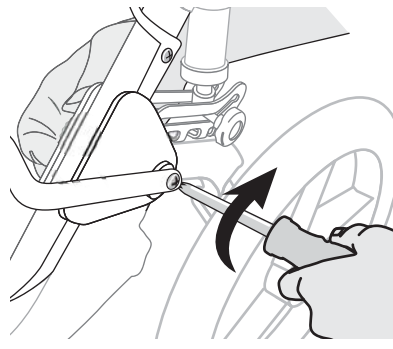

10 REPEAT STEPS 8 AND 9 FOR OTHER SIDE.

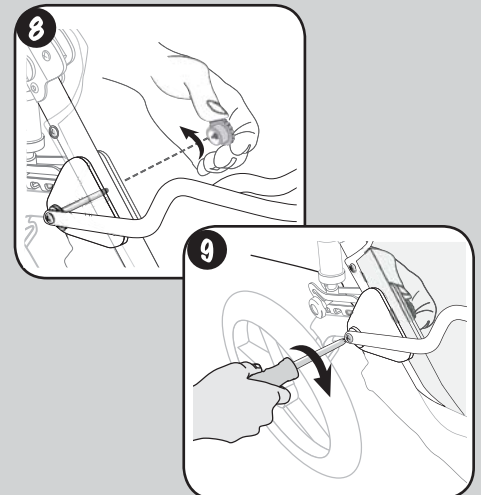

ATTACH RESTRAINT BELT M/F AND ARMS

11 LOCATE FABRIC SCREWS

Extend canopy to expose lower fabric screw.

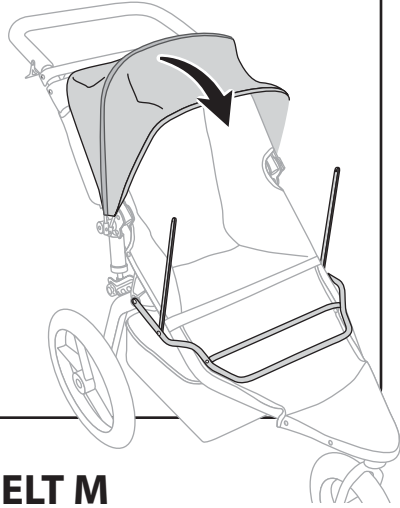
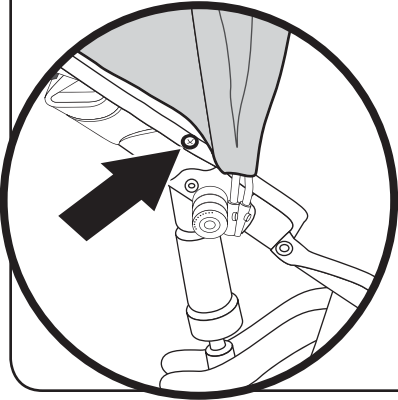

12 REMOVE FABRIC SCREW

Remove screw with Phillips screwdriver, exposing fabric grommet and rivet nut.

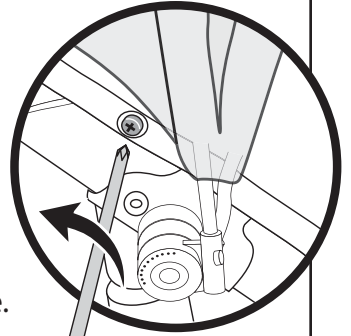

Repeat on other side.

ATTACH RESTRAINT BELT M

13 POSITION ARM

Position **arm** between canopy and frame.

Align **arm hole** over fabric grommet and rivet nut.

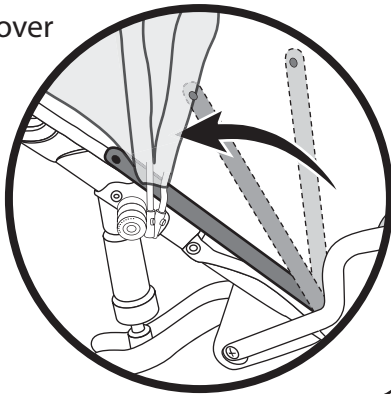

14 POSITION RESTRAINT BELT M

Slide **restraint belt M** grommet between end of **arm** and fabric grommet.

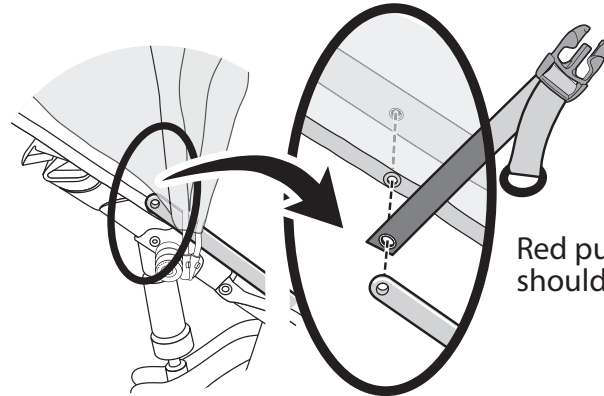

Red pull ring should face out.

15 INSERT SHARP SCREW

Insert **sharp screw** through end of **arm**, **restraint belt M** grommet, fabric grommet and into rivet nut.

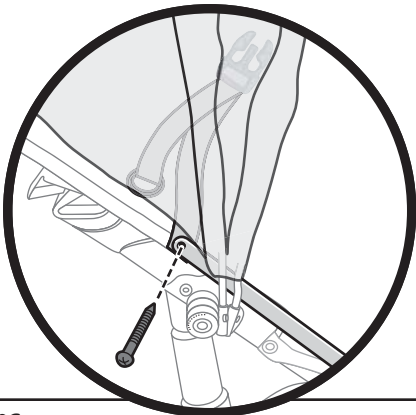

16 TIGHTEN SHARP SCREW

Hold strap at a 90 degree angle.



Tighten firmly with Phillips screwdriver.

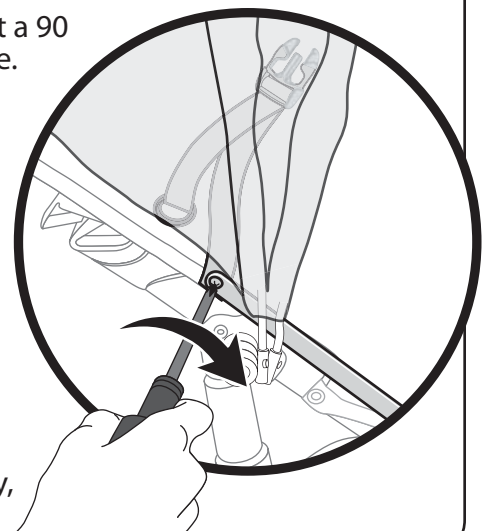

Note:

If screw does not turn easily, unscrew and start again.

ATTACH RESTRAINT BELT F

17 BUCKLE BELT

Connect **restraint belt F** to **restraint belt M**.

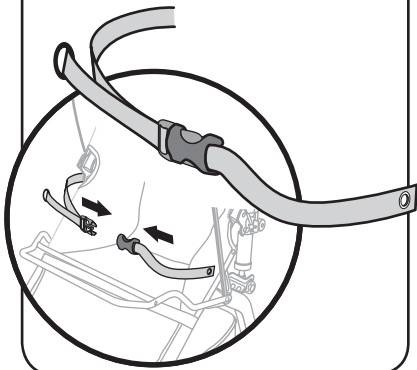

18 POSITION ARM

Position **arm** between canopy and frame.

Align **arm hole** over fabric grommet and rivet nut.

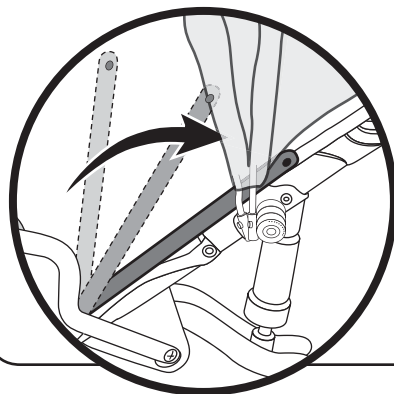

19 POSITION RESTRAINT BELT F

Slide **restraint belt F** grommet between end of **arm** and fabric grommet.

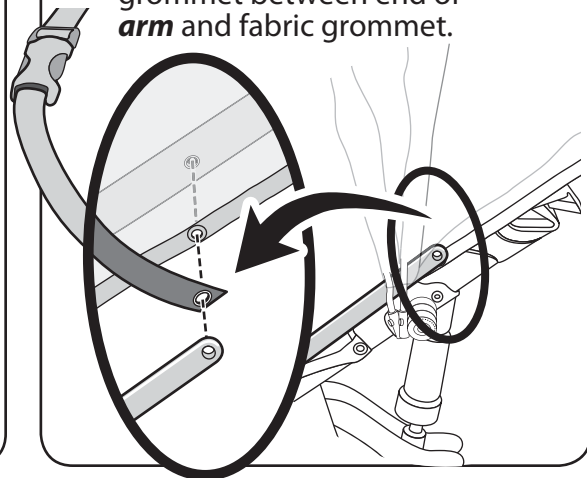

20 INSERT SHARP SCREW

Insert **sharp screw** through end of **arm, restraint belt** grommet, fabric grommet and into rivet nut.

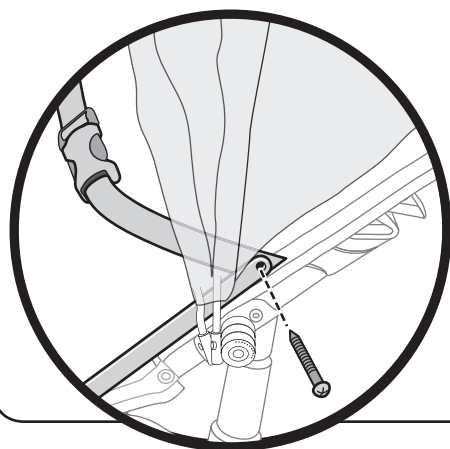

21 TIGHTEN SHARP SCREW

Hold strap at a 90 degree angle.

90°

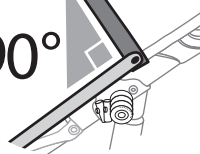

Tighten firmly with Phillips screwdriver.

Note:

If screw does not turn easily, unscrew and start again.

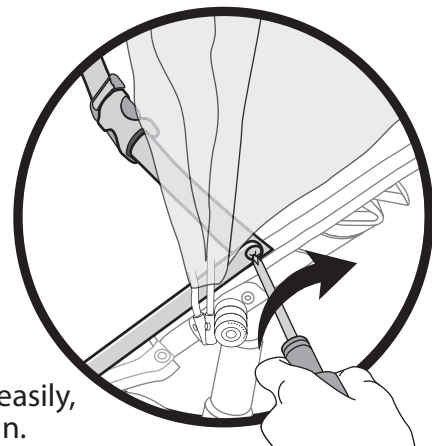

PREPARE STROLLER FOR INFANT CAR SEAT INSTALLATION

22 SET PARKING BRAKE

See the "Parking Brake" section of your stroller owner's manual.

23 POSITION CANOPY

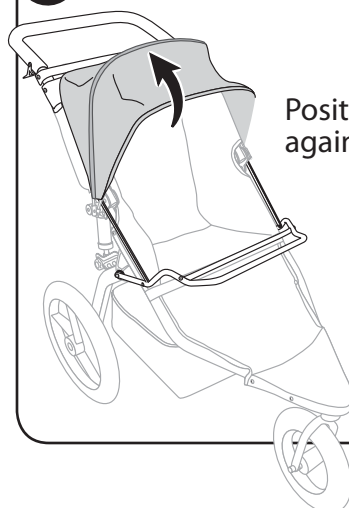

Position canopy against handle bar.

24 UNBUCKLE RESTRAINT BELT

Unbuckle **restraint belt**. Place ends outside seat.

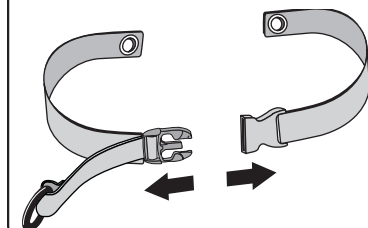

INSTALL INFANT CAR SEAT

Warning

When installing car seat in the ICSA for the first time, test fit with the car seat unoccupied to ensure you understand the process. Installing occupied Infant Car Seat on ICSA for first time may result in accident, serious injury or death.

Britax® Go To **25**

Peg Pérego® Go To **32**

Graco® Go To **39**

Britax®

25 LOWER SEAT BACK

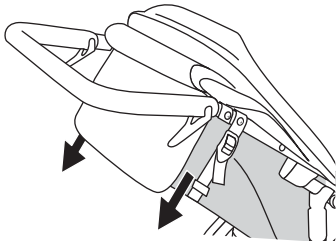

Lower seat back 7" to 8". See "Reclining Seat" section of your stroller owner's manual.

26 RAISE HANDLE

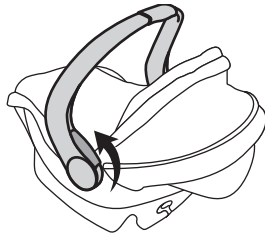

Move car seat handle into upright carrying position.

27 POSITION CAR SEAT

Place car seat "rear facing" onto ICSA **accessory bar**, in a straight downward motion.

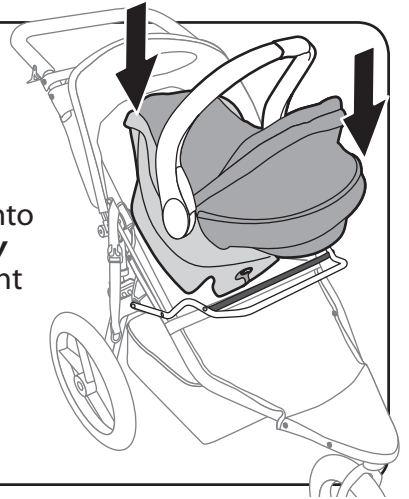

28 ENGAGE CAR SEAT

Slide grooves on underside of car seat onto ICSA accessory bar.

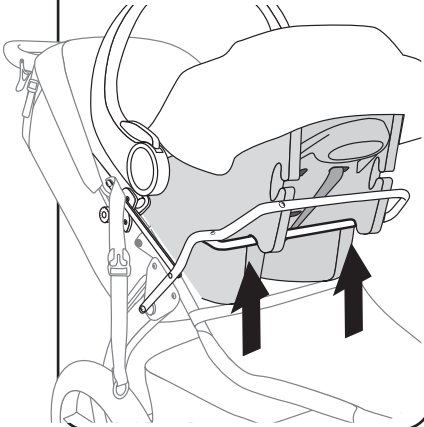

29 FASTEN RESTRAINT BELT

Fasten **restraint belt** over top of infant car seat as shown.

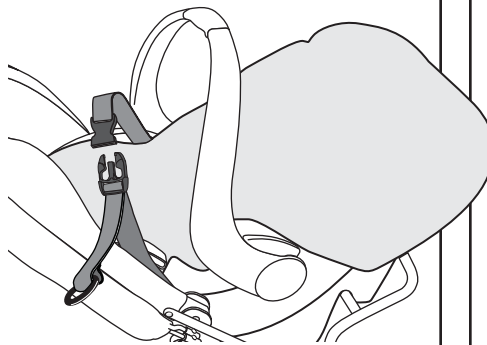

30 TIGHTEN RESTRAINT BELT

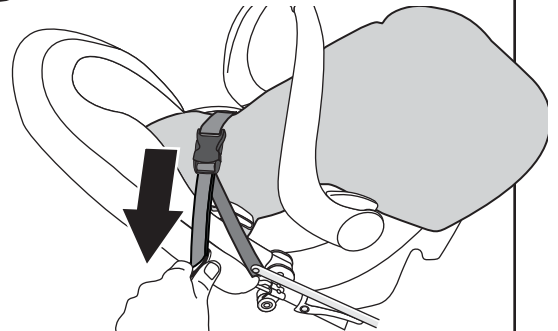

Pull on red ring to tighten.

Warning

Be sure restraint belt tension is not constricting child as it may cause serious injury.

31 DOUBLE CHECK CAR SEAT IS SECURELY ATTACHED

Pull car seat upward without removing restraint belt.

You should not be able to remove car seat without unfastening restraint belt.

Warning

Failure to securely attach car seat may result in serious injury or death.

TO REMOVE Britax®

Go To **47**

32 RAISE SEAT BACK

See the "Reclining Seat" section of your stroller owner's manual.

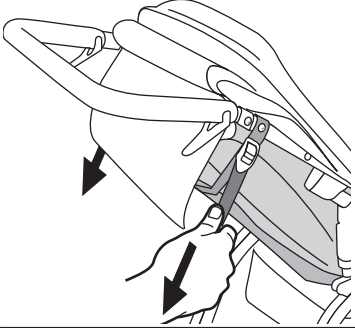

33 POSITION HANDLE

Move car seat handle into upright carrying position.

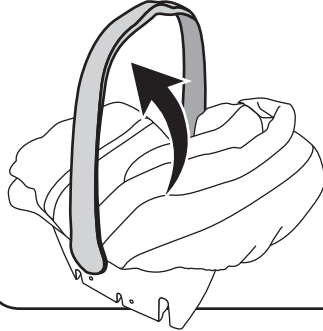

34 POSITION CAR SEAT

Place car seat "rear facing" onto ICSA accessory bar, in a straight downward motion.

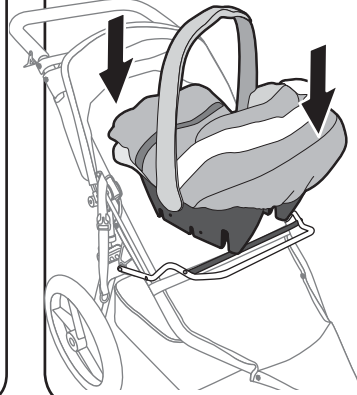

35 ENGAGE CAR SEAT

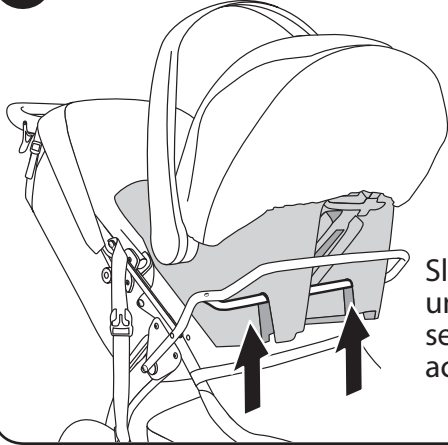

Slide grooves on underside of car seat onto ICSA accessory bar.

36 FASTEN RESTRAINT BELT

Fasten restraint belt over top of infant car seat as shown.

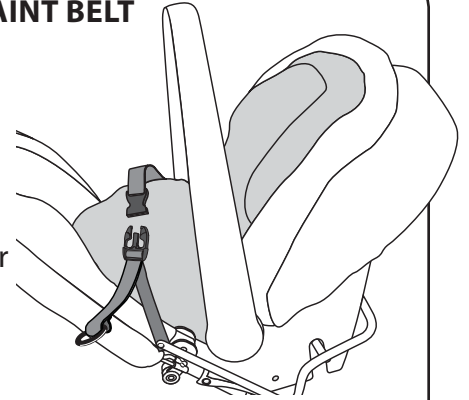

37 TIGHTEN RESTRAINT BELT

Pull on red ring to tighten.

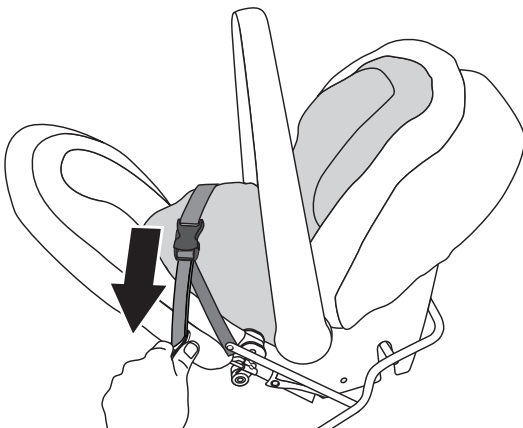

Warning

Be sure restraint belt tension is not constricting child as it may cause serious injury.

38 DOUBLE CHECK CAR SEAT IS SECURELY ATTACHED

Pull car seat upward without removing restraint belt.

You should not be able to remove car seat without unfastening restraint belt.

Warning

Failure to securely attach car seat may result in serious injury or death.

TO REMOVE Peg Pérego®

Go To **47**

39 RAISE SEAT BACK

See the "Reclining Seat" section of your stroller owner's manual.

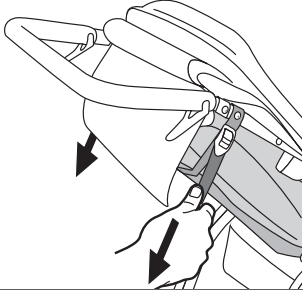

40 REMOVE ACCESSORY BAR

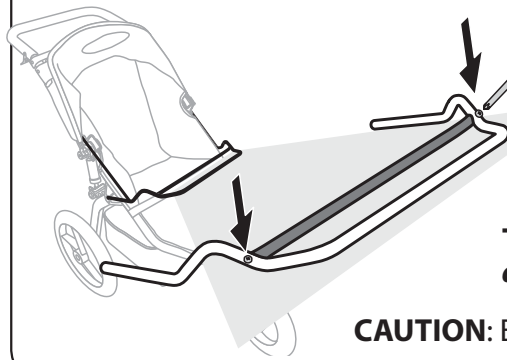

Using a Phillips screwdriver, remove both screws.

TIP: Attach *short screws* to *accessory bar* for future use.

CAUTION: Ends of *accessory bar* are sharp!

41 POSITION HANDLE

Move car seat handle into upright carrying position.

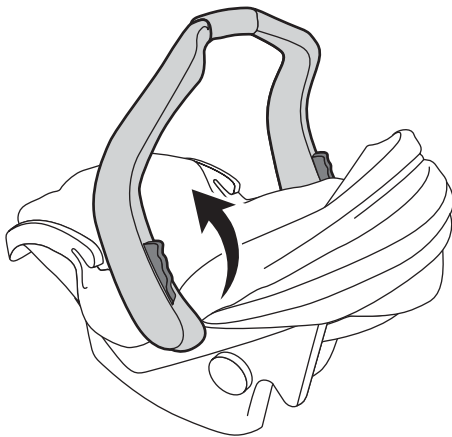

42 POSITION CAR SEAT

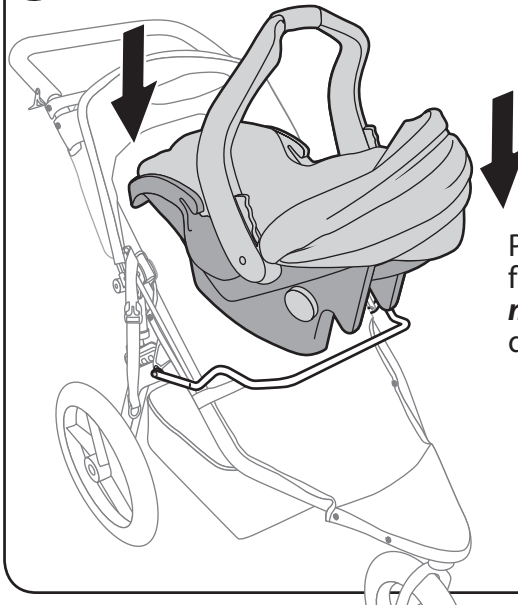

Place car seat "rear facing" onto ICSEA *main bar*, in a straight downward motion.

43 ENGAGE CAR SEAT

Slide grooves on underside of car seat onto ICSEA *main bar*.

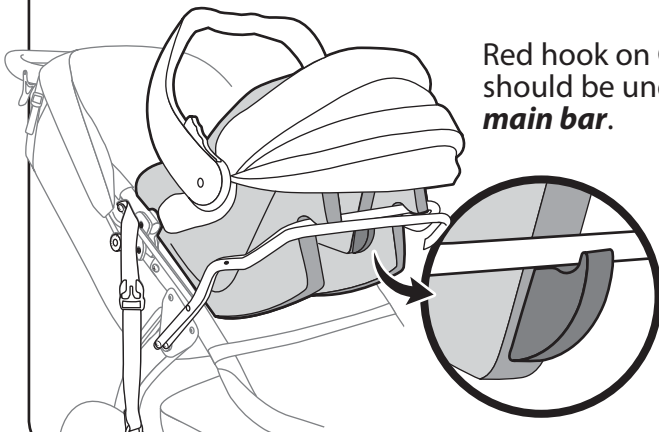

Red hook on Graco® should be under *main bar*.

44 FASTEN RESTRAINT BELT

Fasten *restraint belt* over top of infant car seat as shown.

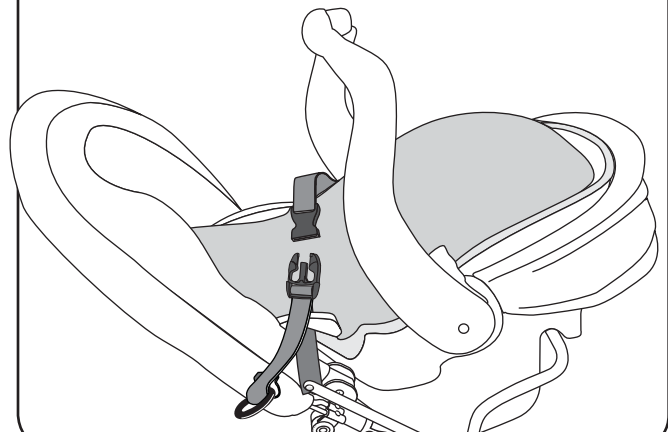

45 TIGHTEN RESTRAINT BELT

Pull on red ring to tighten.

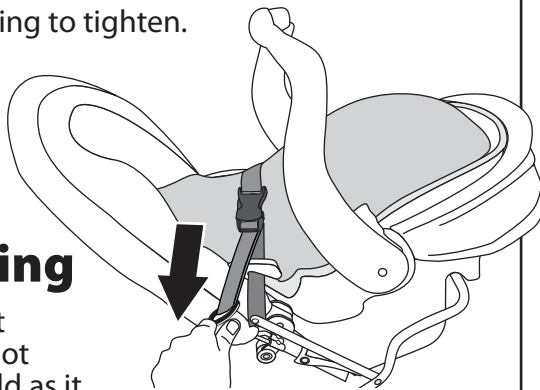

Warning

Be sure restraint belt tension is not constricting child as it may cause serious injury.

46 DOUBLE CHECK CAR SEAT IS SECURELY ATTACHED

Pull car seat upward without removing restraint belt.

You should not be able to remove car seat without unfastening restraint belt.

Warning

Failure to securely attach car seat may result in serious injury or death.

TO REMOVE Graco® Go To 47

TO REMOVE CAR SEAT

47 SET PARKING BRAKE

See the "Parking Brake" section of your stroller owner's manual.

48 UNFASTEN RESTRAINT BELT

Unfasten **restraint belt**. Place ends outside seat.

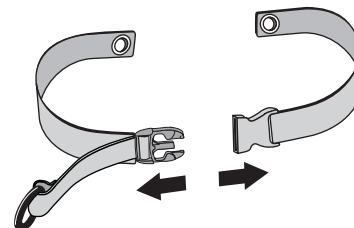

49 REMOVE CAR SEAT

Britax® Peg Pérego®

With car seat handle in upright position, lift car seat straight up and off ICSA bar.

Graco®

With car seat handle in upright position, squeeze red release button under Graco® car seat canopy, lift car seat straight up and off ICSA bar.

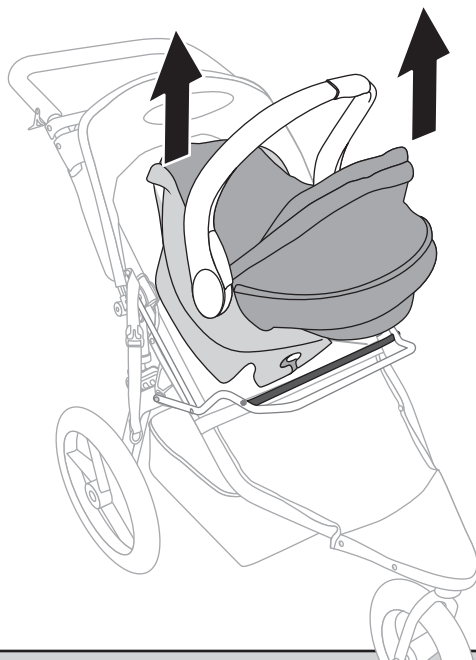

50 FASTEN RESTRAINT BELT

Fasten **restraint belt** when not in use.

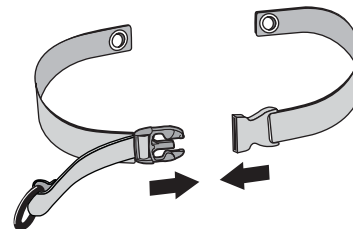

TRAY INSTALLATION

Warning

Children should not be placed directly in the BOB Stroller seat with the ICSA installed, unless tray is installed for safety and protection.

51 REMOVE ACCESSORY BAR

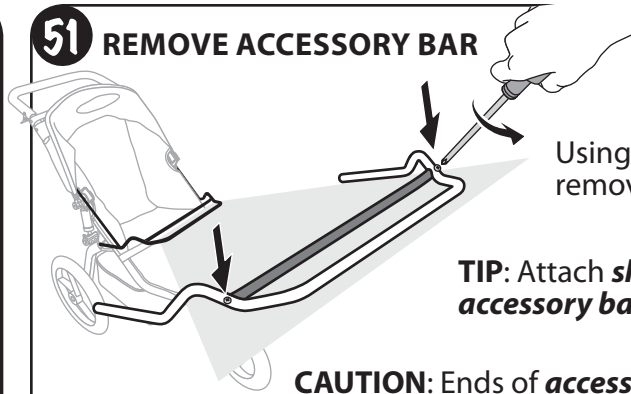

Using a Phillips screwdriver, remove both screws.

TIP: Attach *short screws* to *accessory bar* for future use.

CAUTION: Ends of *accessory bar* are sharp!

52 REMOVE SCREWS

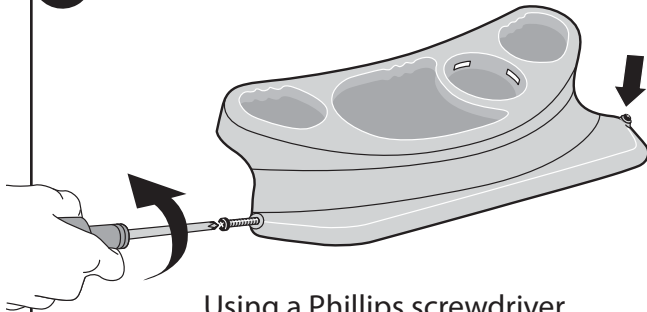

Using a Phillips screwdriver, remove *long screws* from *tray*.

53 ENGAGE TRAY

Hook tray onto main bar.

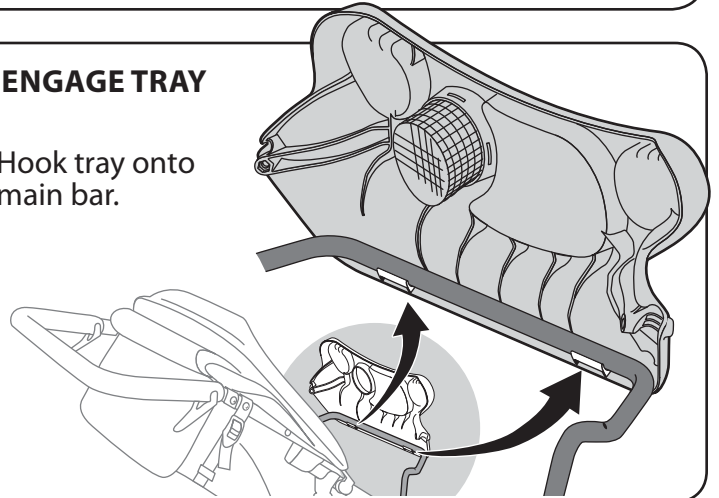

54 ROTATE TRAY

Rotate *tray* towards stroller seat until it rests on *main bar*.

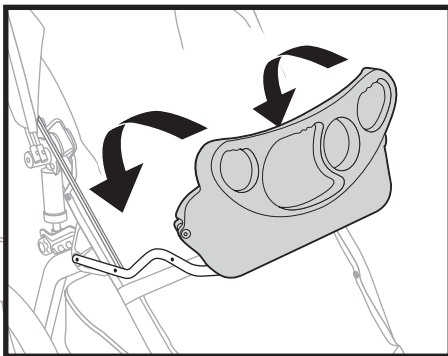

Line up holes.

55 SECURE TRAY

Insert *long screw* through each hole in *tray*, *main bar* and into nut on underside of *tray*.

Tighten firmly with Phillips screwdriver.

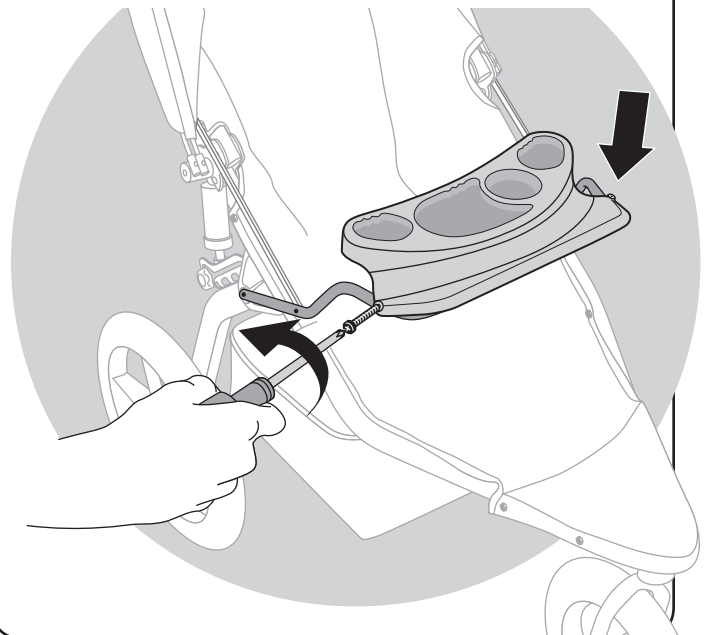

REMOVE RESTRAINT BELT M

56 REMOVE SHARP SCREW AND BELT

Using a Phillips screwdriver, remove **sharp screw** and **restraint belt M**.

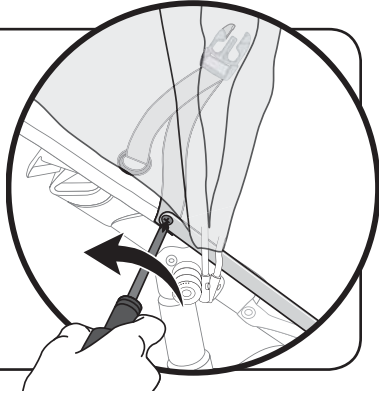

57 POSITION ARM

Position **arm** between canopy and frame.
Align **arm hole** over fabric grommet and rivet nut.

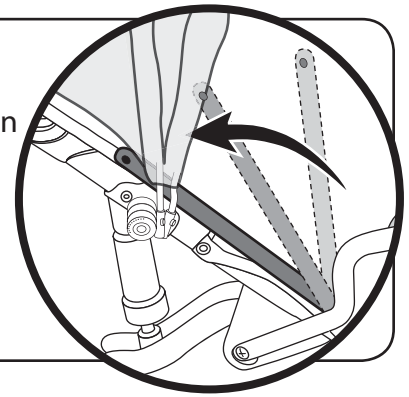

58 REPLACE SHARP SCREW

Insert **sharp screw** through end of **arm**, fabric grommet and into rivet nut.

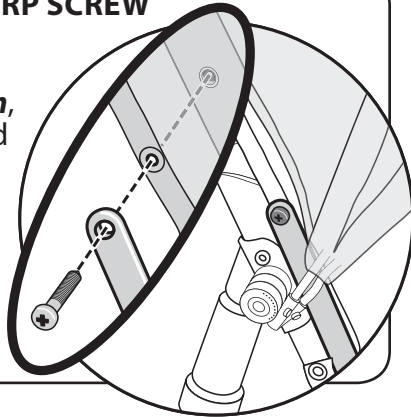

59 TIGHTEN SHARP SCREW

Tighten firmly with Phillips screwdriver.

Note:

If screw does not turn easily, unscrew and start again.

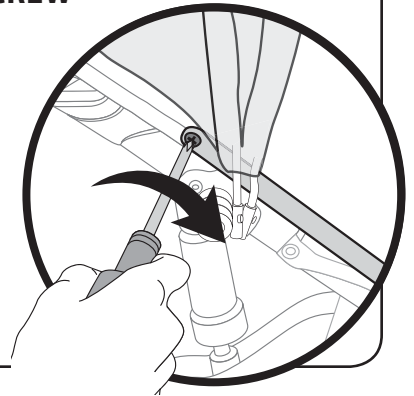

REMOVE RESTRAINT BELT F

60 REMOVE SHARP SCREW AND BELT

Using a Phillips screwdriver, remove **sharp screw** and **restraint belt F**.

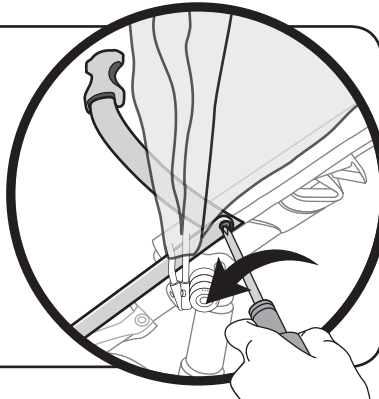

61 POSITION ARM

Position **arm** between canopy and frame.
Align **arm hole** over fabric grommet and rivet nut.

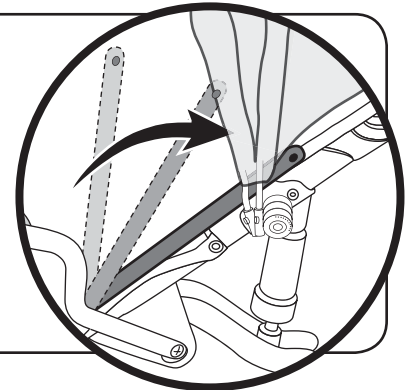

62 REPLACE SHARP SCREW

Insert **sharp screw** through end of **arm**, fabric grommet and into rivet nut.

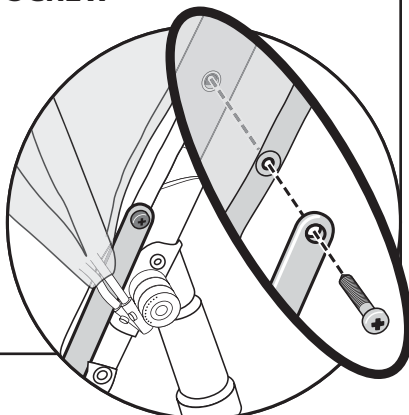

63 TIGHTEN SHARP SCREW

Tighten firmly with Phillips screwdriver.

Note:

If screw does not turn easily, unscrew and start again.

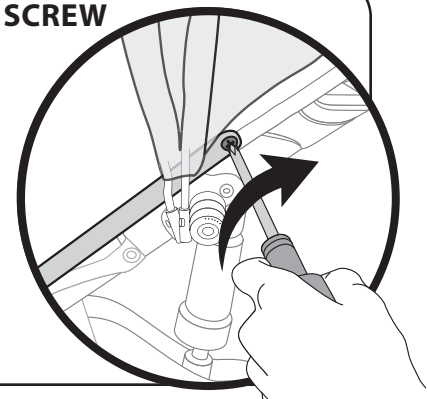



Infant Car Seat Adapter Warnings



- The BOB Infant Car Seat Adapter is designed for use with single seat BOB Strollers and compatible Infant Car Seats. This product is not a universal adapter. Do not use with car seats and stroller models other than those specifically listed in the Stroller and Car Seat Compatibility charts listed on page 1.
- Children should not be placed directly in the BOB Stroller seat with the ICSA installed, unless tray is installed directly in front of child for safety and protection.
- The ICSA Restraint Belt can interfere with proper function of the safety harness system. Additionally, the ICSA Accessory Bar can interfere with accessibility to the stroller seat. Therefore, prior to placing child directly in stroller seat, the ICSA Restraint Belt and Accessory Bar must be removed from the stroller AND the Tray must be installed. Failure to do so may result in serious injury or death.
- Read and understand all owner's manuals and warnings for all BOB products used with the ICSA before use.
- Read and understand infant car seat owner's manual before use.
- Always use seat harness of Infant Car Seat to avoid children falling out of stroller.
- Maximum capacity 17.5lb (weight of infant including clothing). Exceeding capacity may cause stroller to become unstable.
- Follow assembly instructions. Failure to properly install this accessory product may result in accidents, severe injury or death. If you are not sure you can properly install this accessory, contact your BOB retailer and arrange for them to perform the installation.
- Never leave children unattended in the stroller/infant car seat.
- Always secure the infant car seat with the restraint belt when the car seat is placed in the stroller. Failure to do so may result in serious injury or death.
- Always keep your Infant Car Seat handle in the vertical and locked position while in stroller, as extra protection for your child.
- Stroller may become unstable if parcel bags are incorrectly attached or if bags other than those recommended by BOB Trailers, Inc. are used.
- Do not run or jog when using the ICSA with car seat installed. Doing so may result in serious injury or death.
- Do not use off-road or on uneven terrain when using the ICSA with car seat installed. Doing so may cause stroller to become unstable and result in accident, serious injury or death.
- Children develop at different rates. Consult with your pediatrician regarding the suitability of the stroller use with your child.

BOB IS NOT RESPONSIBLE FOR INJURY, DAMAGE OR FAILURE THAT RESULTS FROM OWNERS FAULTY ASSEMBLY OR MAINTENANCE AFTER SHIPPING.

BOB is a company that produces high quality products designed to promote a healthy outdoor life-style. Go to www.bobgear.com for our complete line of products. **Before attempting to assemble or use your new ICSA, read and understand these instructions completely to insure proper assembly and operation.**

If you are unclear on any point, contact your dealer, place of purchase or BOB [toll free 1-800-893-2447] before use. A list of dealers is listed on our website [www.bobgear.com]. For updates to this manual, our warranty and for other recent product notifications, please visit www.bobgear.com periodically.

B.O.B, B.O.B Logo, and BOB are proprietary trademarks of BOB Trailers, Inc.

Britax® and Companion® are registered trademarks of Britax Excelsior Ltd. and related companies.

Graco® Snug Ride™ and SafeSeat™ are registered and proprietary trademarks of Graco Children's Products, Inc.

Peg Pérego® Primo Viaggio™ and Primo Viaggio SIP™ are registered and proprietary trademarks of Peg Pérego S.P.A. Corporation.

LIMITED WARRANTY

BOB Trailers Inc. takes pride in its workmanship and strives to manufacture the best products possible. Therefore, we warranty the ICSA against defects in material and workmanship subject to the conditions listed below. Since no product is indestructible, it does not cover defects attributable to or resulting from normal wear, abuse or alteration.

- **The ICSA is warranted for one year from the date of original purchase.**
- **Warranty is only valid for the original purchaser.**
- **Proof of purchase is required to exercise this warranty.**
- **Labor and freight charges are not included.**
- **Normal wear, neglect, abuse, accidents, and improper use are not covered by this warranty.**
- **Warranty claims must be made through an authorized dealer.**
- **This warranty is limited to the repair or replacement of the defective part. BOB Trailers, Inc. shall in no event be responsible for consequential or special damages.**
- **This Limited Warranty is the only express or implied warranty applicable to BOB Trailers, Inc. Any implied warranties, including warranties of merchantability and fitness shall be limited in scope and duration in accordance with this limited warranty.**