



BOB® Trailers, Inc. (800) 893-2447 www.bobgear.com
Mail: 13501 South Ridge Drive, Charlotte, North Carolina 28273

INFANT CAR SEAT ADAPTER INSTRUCTIONS

Single and Duallie®

ENGLISH

TAKE TIME

READ AND UNDERSTAND THESE INSTRUCTIONS COMPLETELY!

Before attempting to assemble or use your new Infant Car Seat Adapter, read and understand these assembly and use instructions completely, as well as the warnings at the beginning and throughout this document, to ensure proper assembly and operation.

**If you are unclear on any point, contact your dealer or BOB before use.
For a list of dealers, visit www.bobgear.com or call (800) 893-2447.**



WARNINGS



**FAILURE TO FOLLOW THESE WARNINGS AND ASSEMBLY INSTRUCTIONS
COULD RESULT IN SERIOUS INJURY OR DEATH.**

- Please save instructions for future use and reference.
- For safe operation, all users must read and understand instructions and warnings completely before use.
- The BOB Infant Car Seat Adapter is designed for use with BOB Strollers equipped with Accessory Adapters and compatible Infant Car Seats. This product is not a universal adapter. Do not use with car seats and/or stroller models other than those specifically listed in the stroller and Infant Car Seat Compatibility Charts listed on page 4.
- Maximum capacity 17.5lb (weight of infant including clothing). Exceeding capacity may cause stroller to become unstable.
- Avoid serious injury from falling or sliding out. Always use Infant Car Seat harness.
- For Duallie Strollers, the Canopy Catch is intended to prevent the right canopy from rotating and causing pinching and/or finger injuries between canopy stays and Infant Car Seat. Always secure right canopy stay in Canopy Catch when using an Infant Car Seat in Infant Car Seat Adapter.
- Never leave children unattended in the stroller/Infant Car Seat.
- Always keep your Infant Car Seat Carry Handle locked in the vertical/carry position while in stroller, as extra protection for your child.
- Always confirm Infant Car Seat Adapter is properly locked in place in stroller Accessory Adapter prior to use.
- Always confirm Infant Car Seat is properly locked in place on Infant Car Seat Adapter prior to use.
- Always secure the Infant Car Seat to the Infant Car Seat Adapter with the supplied Restraint Belt.
- Do not run or jog when using Infant Car Seat Adapter with Infant Car Seat.
- Do not use off-road or on uneven terrain when using the Infant Car Seat Adapter with Infant Car Seat installed.
- Remove Infant Car Seat Adapter and Restraint Belt when not in use.
- Do not place children directly in the stroller seat with the Infant Car Seat Adapter installed. Remove Infant Car Seat Adapter from stroller prior to placing a child directly into the stroller seat.
- Restraint Belt is intended for use with combination of BOB Infant Car Seat Adapter and compatible Infant Car Seats only. The Restraint Belt must be removed prior to using stroller without Infant Car Seat.

CONGRATULATIONS

Congratulations on your purchase of the BOB® Infant Car Seat Adapter (ICSA). It is designed to allow the attachment of an Infant Car Seat to a BOB stroller.

Please refer to charts on page 4 for details of compatible ICSA models, BOB strollers and Infant Car Seats. Find your compatible Infant Car Seat on the chart on page 4. Find key features of your ICSA on Anatomy pages and follow respective instructions.

For updates to this manual, warranty and other recent product notifications, Please visit www.bobgear.com periodically or any time before making approved changes or adding approved equipment to your stroller.

- Do not modify the Infant Car Seat Adapter or any labels. Doing so voids the warranty and could lead to a dangerous condition.
- Care must be taken when attaching Infant Car Seat to Infant Car Seat Adapter to make sure hands and fingers are clear of contacting surfaces.
- Care must be taken when folding and unfolding the stroller to prevent finger entrapment or injury.
- To avoid injuries, never fold or unfold stroller with other individuals within reach of stroller.
- Plastic bags can be dangerous. Keep plastic bags and other packaging away from children and infants.

TABLE OF CONTENTS

Warnings	2
Table of Contents	3
Compatibility Chart	4
Anatomy	5
CS1001 ICSA for Graco® Anatomy	5
Graco® Snug Ride® Infant Car Seat Anatomy	5
CS1002 ICSA for Peg Perego® Anatomy	6
Peg Perego® Primo Viaggio SIP™ Infant Car Seat Anatomy	6
CS1003 ICSA for Chicco® Anatomy	7
Chicco® KeyFit™ Infant Car Seat Anatomy	7
CS1104 ICSA for Britax® Anatomy	8
Britax® Click & Go Infant Car Seat Anatomy	8
CS1011 ICSA Duallie for Graco® Anatomy	9
Graco® Snug Ride® Infant Car Seat Anatomy	9
Stroller Accessory Adapter Anatomy	10
Restraint Belt Anatomy	10
Canopy Catch Anatomy (CS1011 Only)	10
Instructions	11
Installing Your ICSA	11
Attach Restraint Belt	11
Install Canopy Catch	12
Attach ICSA to Stroller	12
Prepare Stroller for ICSA	12
Install ICSA	13
Preparing to Attach Infant Car Seat	13
Infant Car Seat Installation	14
Graco® Infant Car Seat Installation	14
Peg Perego® Infant Car Seat Installation	15
Chicco® Infant Car Seat Installation	16
Britax® Infant Car Seat Installation	17
Secure Restraint Belt	18
Remove Infant Car Seat from Stroller	18
Folding Stroller with ICSA Attached	18
Remove ICSA from Stroller	19
Removing Restraint Belt from Stroller	20
Limited Warranty	21

BOB IS NOT RESPONSIBLE FOR INJURY, DEATH, DAMAGE OR FAILURE THAT RESULTS FROM OWNER'S FAULTY ASSEMBLY, USE OR MAINTENANCE.

COMPATIBILITY CHART

INFANT CAR SEAT COMPATIBILITY CHART

BOB ICSA Model	Infant Car Seat Brand	Infant Car Seat Model
CS1001 - Single	Graco®	Snug Ride®
		Snug Ride® 30
		Snug Ride® 32
		Snug Ride® 35
CS1002 - Single	Peg Perego®	Primo Viaggio SIP™
		Primo Viaggio SIP 30/30™
CS1003 - Single	Chicco®	KeyFit™
		KeyFit™ 30
CS1104 - Single	Britax®	B-SAFE™
		CHAPERONE™*
CS1011 - Duallie®	Graco®	Snug Ride®
		Snug Ride® 30

*See Infant Car Seat user guide for Click & Go adapter installation.

⚠ WARNING

The BOB Infant Car Seat Adapter is designed for use with BOB Strollers equipped with Accessory Adapters and compatible Infant Car Seats. This product is not a universal adapter. Do not use with car seats and/or stroller models other than those specifically listed in the stroller and Infant Car Seat Compatibility Charts.

BOB STROLLER COMPATIBILITY CHART

BOB STROLLER	Serial Number (S/N) Range -S/N located on right swingarm, white label on inboard side.	BOB ICSA Model				
		CS1001	CS1002	CS1003	CS1104	CS1011
Sport Utility Stroller	AU000000 and higher	YES	YES	YES	YES	-
Ironman®	AV000000 and higher	YES	YES	YES	YES	-
Revolution® SE	BB000000 and higher	YES	YES	YES	YES	-
Revolution® CE	AP000000 and higher	YES	YES	YES	YES	-
Stroller Strides®	AQ000000 and higher	YES	YES	YES	YES	-
Sport Utility Stroller Duallie®	AW000000 and higher	-	-	-	-	YES
Ironman® Duallie®	AX000000 and higher	-	-	-	-	YES
Revolution® SE Duallie®	AR000000 and higher	-	-	-	-	YES
Stroller Strides® Duallie®	AT000000 and higher	-	-	-	-	YES

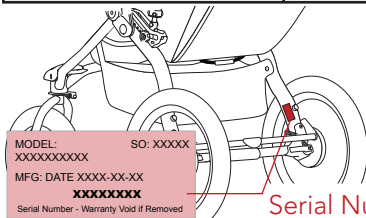

MODEL: XXXXXXXXXXXX
SO: XXXXX
MFG: DATE XXXX-XX-XX
XXXXXXX
Serial Number - Warranty Void if Removed

Serial Number

ANATOMY

CS1001 ICSA FOR GRACO® ANATOMY

Remove ICSA from packaging. Please dispose of packaging material properly, recycle if possible.

NOTE: Note key features of each product. Instructions refer to these features by name.

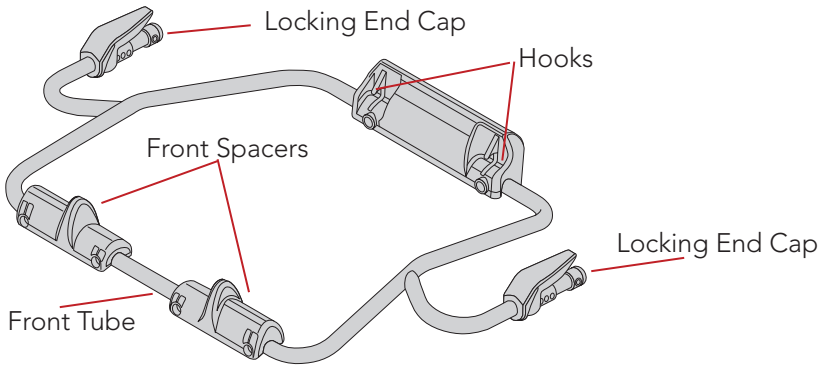

GRACO® SNUG RIDE® INFANT CAR SEAT ANATOMY

NOTE: Snug Ride® model shown, similar key features exist on all compatible Graco® Snug Ride® models. (See Compatibility Chart Page 4).

NOTE: Note key features of each product. Instructions refer to these features by name.

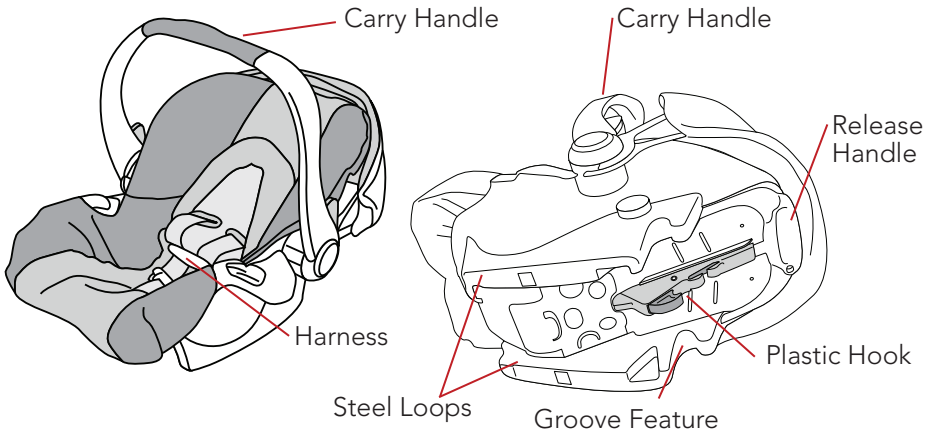

CS1002 ICSA FOR PEG PEREGO® ANATOMY

Remove ICSA from packaging. Please dispose of packaging material properly, recycle if possible.

NOTE: Note key features of each product. Instructions refer to these features by name.

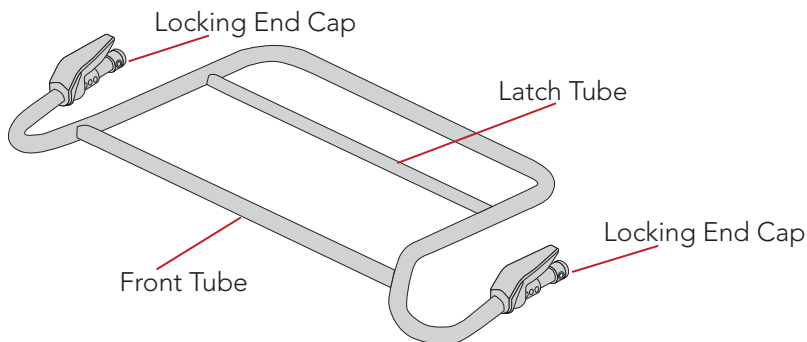

PEG PEREGO® PRIMO VIAGGIO™ INFANT CAR SEAT ANATOMY

NOTE: Primo Viaggio SIP™ model shown, similar features exist on all compatible Peg Perego® Primo Viaggio SIP™ models. (See Compatibility Chart Page 4).

NOTE: Note key features of each product. Instructions refer to these features by name.

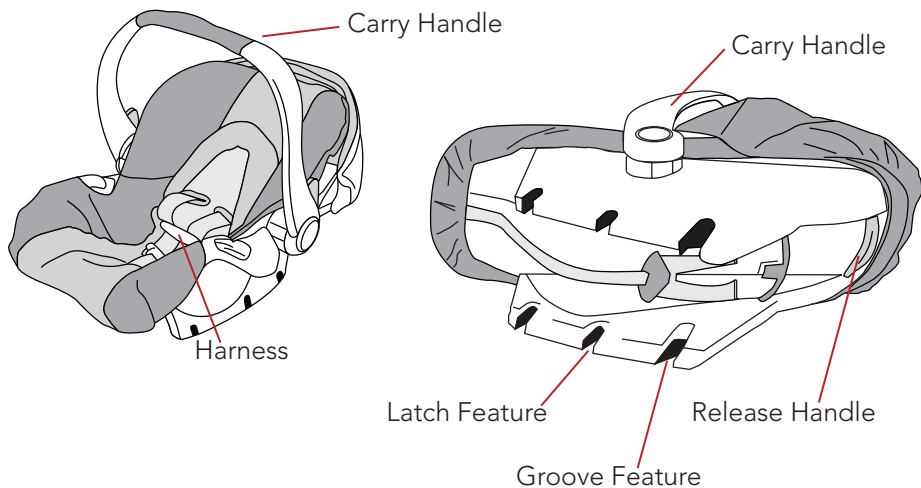

CS1003 ICSA FOR CHICCO® ANATOMY

Remove ICSA from packaging. Please dispose of packaging material properly, recycle if possible.

NOTE: Note key features of each product. Instructions refer to these features by name.

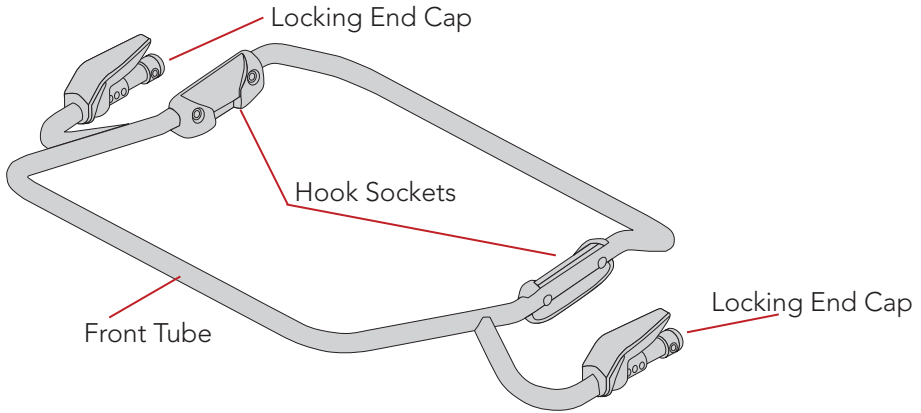

CHICCO® KEYFIT™ INFANT CAR SEAT ANATOMY

NOTE: KeyFit™ model shown, similar key features exist on all compatible Chicco® KeyFit™ models. (See Compatibility Chart Page 4).

NOTE: Note key features of each product. Instructions refer to these features by name.

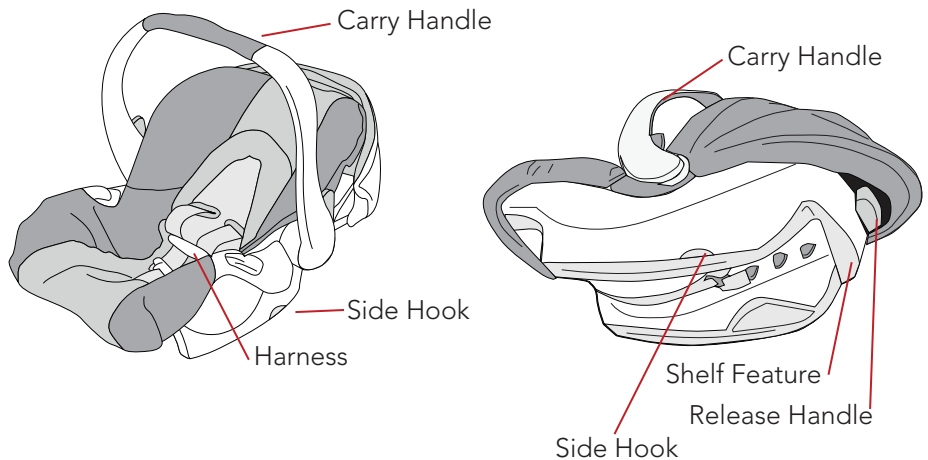

CS1104 ICSA FOR BRITAX® ANATOMY

Remove ICSA from packaging. Please dispose of packaging material properly, recycle if possible.

NOTE: Note key features of each product. Instructions refer to these features by name.

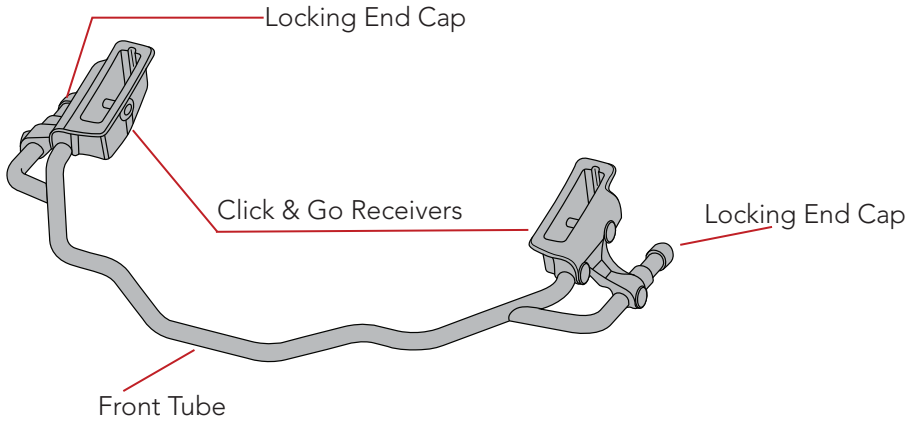

See Infant Car Seat user guide for Click & Go adapter installation.

BRITAX® INFANT CAR SEAT ANATOMY

NOTE: Britax™ model shown, similar key features exist on all compatible Britax® Click & Go models. Click & Go removable adapters are required to install a Britax Infant Car Seat. See Infant Car Seat user guide for Click & Go adapter installation.

NOTE: Note key features of each product. Instructions refer to these features by name.

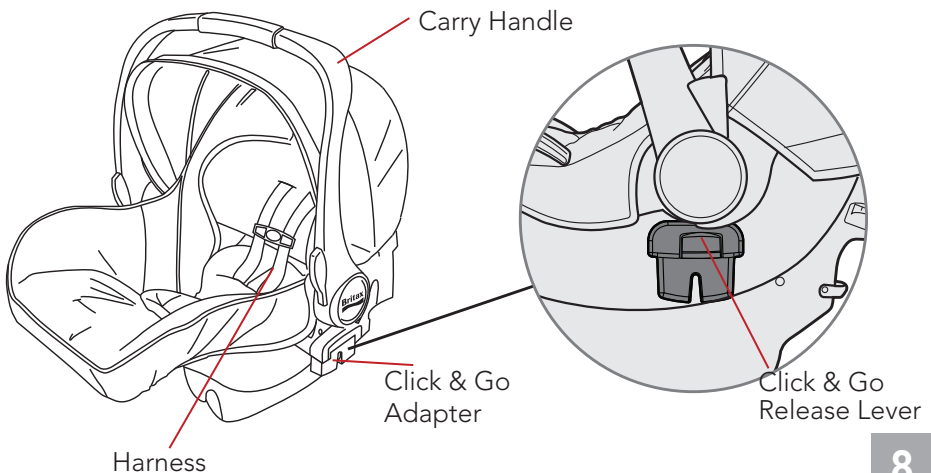

CS1011 ICSA DUALIE FOR GRACO® ANATOMY

Remove ICSA from packaging. Please dispose of packaging material properly, recycle if possible.

NOTE: Note key features of each product. Instructions refer to these features by name.

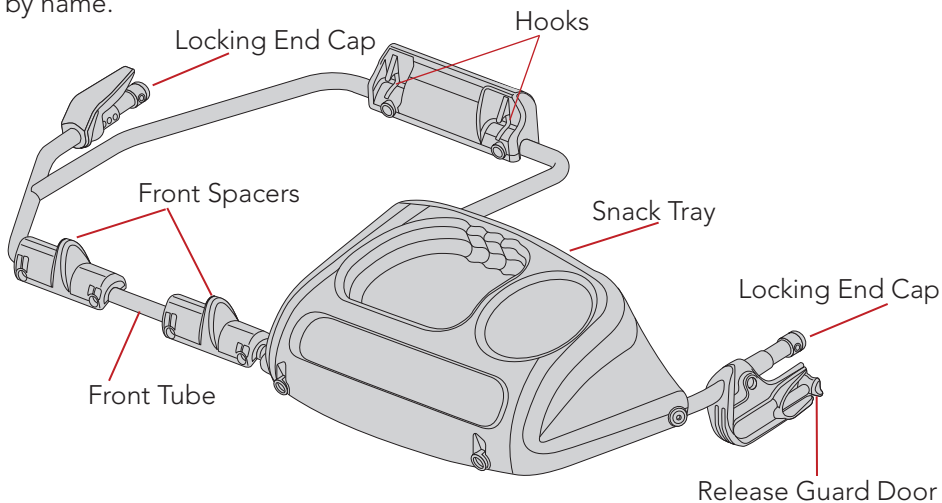

GRACO® SNUG RIDE® INFANT CAR SEAT ANATOMY

NOTE: Snug Ride® model shown, similar key features exist on all compatible Graco® Snug Ride® models. (See Compatibility Chart Page 4).

NOTE: Note key features of each product. Instructions refer to these features by name.

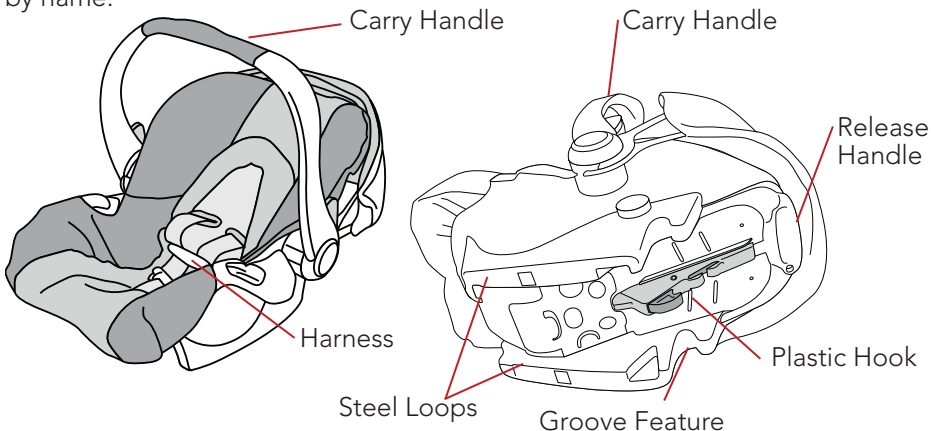

STROLLER ACCESSORY ADAPTER ANATOMY

SINGLE & DUALLIE

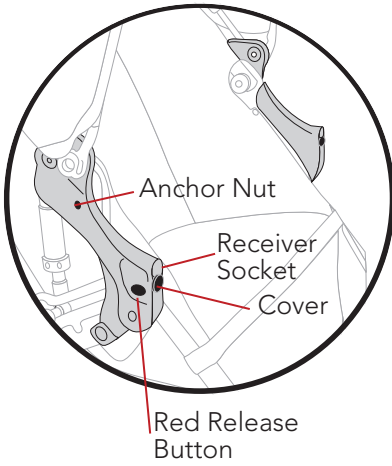

DUALLIE - Center Canopy Mount

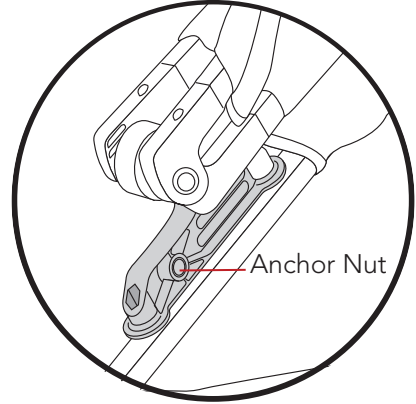

RESTRAINT BELT ANATOMY

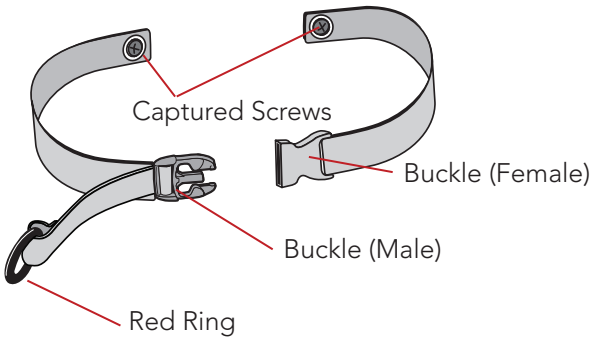

CANOPY CATCH ANATOMY (CS1011 ONLY)

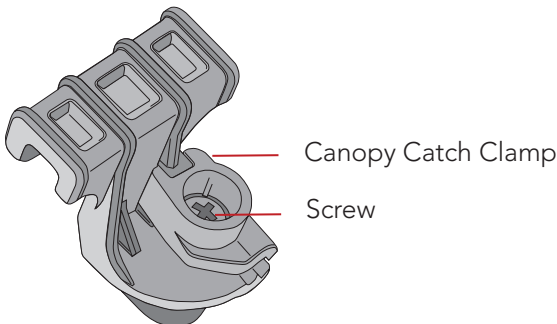

INSTRUCTIONS

INSTALLING YOUR ICSA

ATTACH RESTRAINT BELT

1. Prepare Stroller

Set parking brake, rotate canopy towards handlebar. (See stroller owner's manual if necessary).

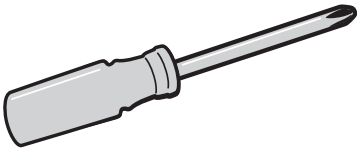

2. Install Restraint Belt with Screwdriver

Using a screwdriver, thread the Captured Screw with Buckle (Male) completely into Anchor Nut on Right side of stroller Accessory Adapter and tighten firmly.

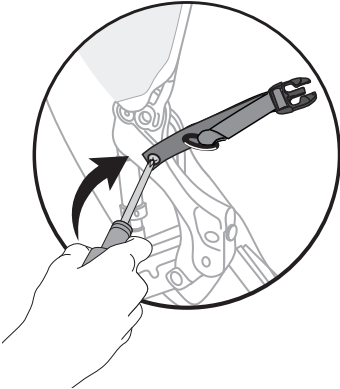

NOTE: For Single strollers, thread the Captured Screw with Buckle (Female) completely into Anchor Nut on Left side of Stroller Accessory Adapter and tighten firmly.

Restraint Belt Installed - SINGLE

Right Side

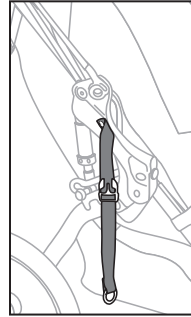

Left Side

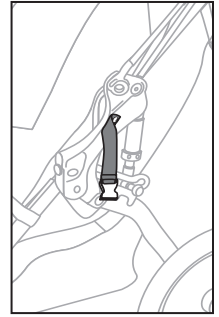

NOTE: For Duallie strollers, thread the Captured Screw with Buckle (Female) completely into Anchor Nut on Left side of Center Canopy Mount (center of stroller between seats) and tighten firmly.

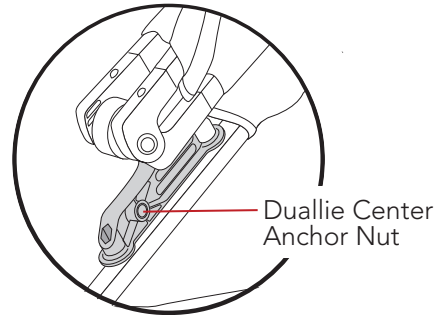

Restraint Belt Installed - DUALLE

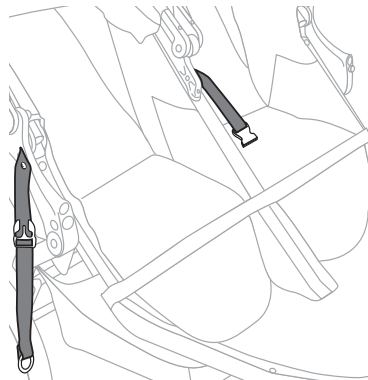

⚠️ WARNING

Confirm each Captured Screw is threaded fully into, and tightened firmly against, each Anchor Nut. Failure to properly secure Restraint Belt may result in accident, injury, or death.

INSTALL CANOPY CATCH

For Duallie Strollers Only

1. Rotate Canopies

Rotate both canopies forward to expose Cross Strap Webbing.

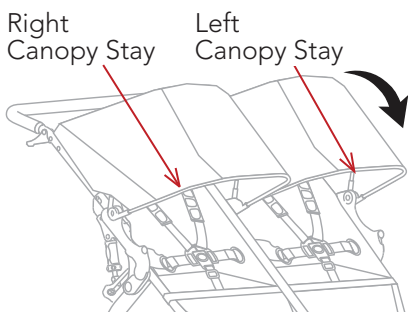

2. Locate Canopy Catch

Slide Canopy Catch over cross strap webbing - making sure Clamp portion is centered between the left and right canopies.

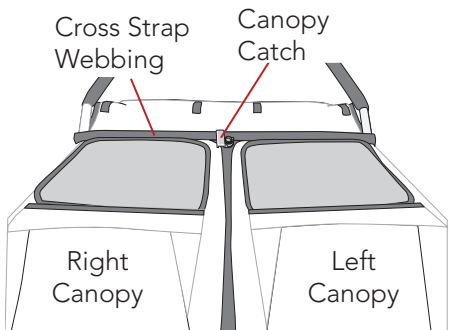

3. Secure Canopy Catch

Hold Canopy Catch in place and tighten screw with screwdriver.

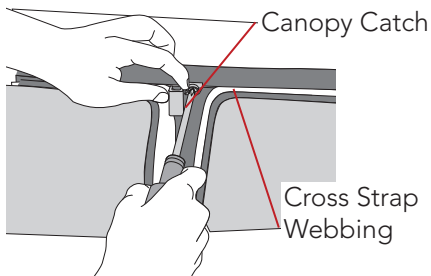

4. Secure Right Canopy

Rotate right canopy back (toward handlebar). Slide right canopy stay under Canopy Catch. Pull on canopy to verify that Canopy Catch securely holds canopy in place.

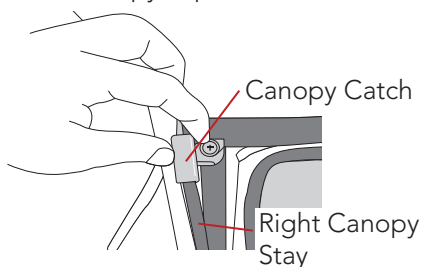

ATTACH ICSA TO STROLLER

PREPARE STROLLER FOR ICSA

1. Prepare Stroller

Set parking brake, rotate canopy towards handlebar. (See stroller owner's manual if necessary).

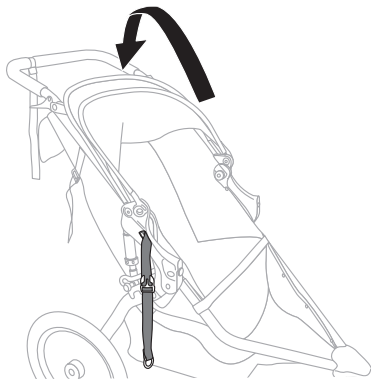

2. Unfasten Restraint Belt Buckle

Unfasten buckle of Restraint Belt and place buckle ends to the sides of stroller seat.

3. Slide Covers Down

Push to slide each Cover (at front of stroller Accessory Adapter) down on each side of stroller, exposing each Receiver Socket.

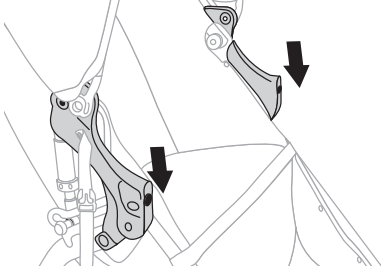

INSTALL ICSA

1. Align Locking End Caps

Align and insert each Locking End Cap on ICSA into each respective Accessory Adapter Receiver Socket.

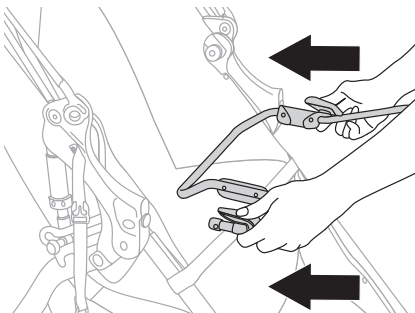

2. Install ICSA

Push ICSA Locking End Caps straight into Receiver Sockets fully. Listen for click or snap noise on each side.

SINGLE

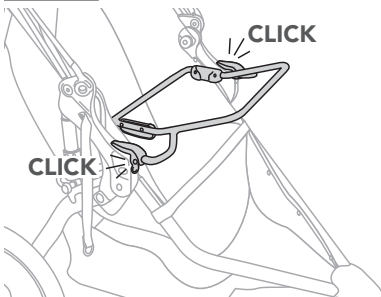

DUALIE

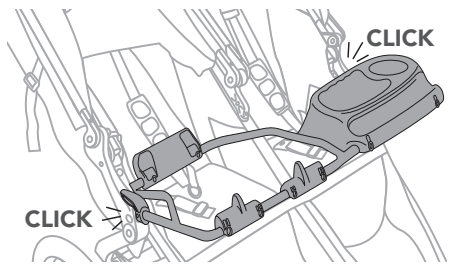

3. Verify Proper Installation

Pull on center of ICSA Front Tube to verify ICSA is securely locked into place.

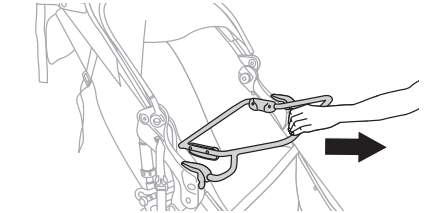

⚠ WARNING

Failure to attach ICSA securely to stroller may result in serious injury or death.

PREPARING TO ATTACH

INFANT CAR SEAT

NOTE: Follow steps 1-3 in this section to prepare car seat and stroller for installation, then proceed to section for your brand car seat and follow installation steps in sequence.

⚠ WARNING

When attaching Infant Car Seat to ICSA for the first time, practice attaching and removing unoccupied Infant Car Seat several times until the function becomes familiar.

⚠ WARNING

Failure to securely attach Infant Car Seat may result in accident, serious injury or death.

1. Prepare Stroller

Set parking brake, rotate canopy towards handlebar, place Restraint Belt ends to the sides of stroller seat. (See stroller owner's manual if necessary).

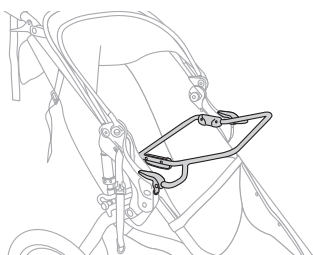

2. Place Infant Into Infant Car Seat

Fasten harness securely. (See Infant Car Seat owner's manual if necessary).

⚠ WARNING

Failure to properly secure infant with seat harness of Infant Car Seat may result in accident, serious injury or death.

3. Position Infant Car Seat Carry Handle

Move Infant Car Seat Carry Handle into upright, carrying position.

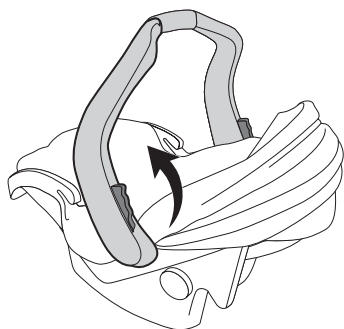

INFANT CAR SEAT

INSTALLATION

Proceed to the section for your brand of Infant Car Seat.

GRACO® INFANT CAR SEAT

INSTALLATION

1. Prepare Stroller

Set parking brake, rotate canopy towards handlebar, place Restraint Belt ends to the sides of stroller seat. (See stroller owner's manual if necessary).

2. Align Infant Car Seat

Place Infant Car Seat "rear facing", directly centered on top of ICSEA, aligning Groove Features of Infant Car Seat with Front Spacers on ICSEA.

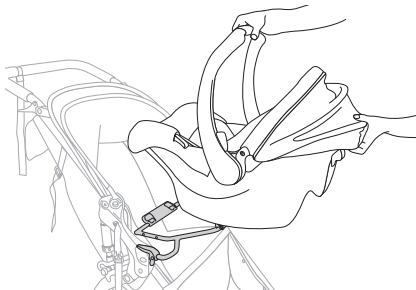

3. Verify Infant Car Seat Latched Properly

Push Infant Car Seat straight down onto ICSEA. "Look and listen for Plastic Hook" on Infant Car Seat to latch under main front tube on ICSEA.

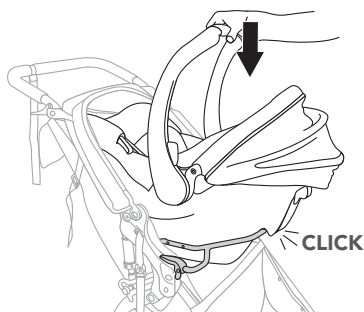

4. Verify Infant Car Seat Hooks are Engaged

Push down on forward edge of Infant Car Seat (end where infant's feet go); listen for Steel Loops on Infant Car Seat to engage over hooks on ICSEA.

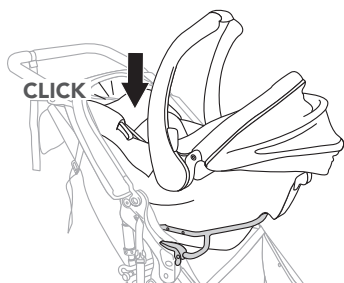

NOTE: For Snug Ride® Models only; Pull Infant Car Seat Release Handle slightly while pushing down on front edge of Infant Car Seat (end where infant's feet go), then let go of Release Handle to engage Steel Loops on Infant Car Seat onto Hooks on ICSA.

5. Verify Infant Car Seat is Securely Attached

Pull up on Infant Car Seat Carry Handle to verify Infant Car Seat is securely attached.

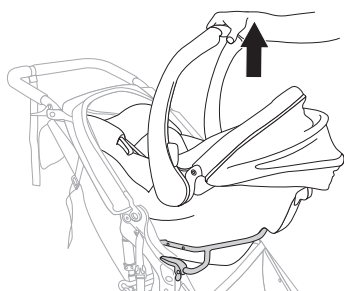

⚠ WARNING

Failure to properly install Infant Car Seat on Infant Car Seat Adapter may result in accident, injury or death.

6. Secure Restraint Belt

Proceed to section titled "Secure Restraint Belt".

⚠ WARNING

Failure to properly secure Restraint Belt may result in accident, injury or death.

1. Prepare Stroller

Set parking brake, rotate canopy towards handlebar, place Restraint Belt ends to the sides of stroller seat. (See stroller owner's manual if necessary).

2. Align Infant Car Seat

Place Infant Car Seat "rear facing" directly centered on top of ICSA, align Groove Feature on Infant Car Seat with Front Tube on ICSA.

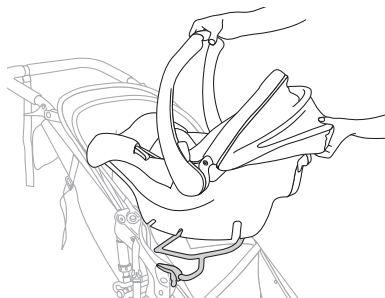

3. Verify Infant Car Seat Latched Properly

Push Infant Car Seat straight down on ICSA, look and listen for each respective Latch Feature on bottom of Infant Car Seat to latch onto Latch Tube on ICSA.

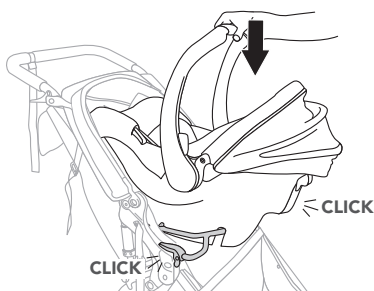

4. Verify Infant Car Seat is Securely Attached

Pull up on Infant Car Seat Carry Handle to verify Infant Car Seat is securely attached.

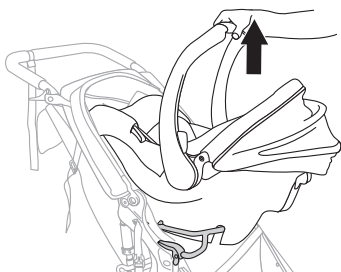

3. Verify Infant Car Seat Latched Properly

Push Infant Car Seat straight down onto ICESA. Look and listen for each Side Hook (on sides of Infant Car Seat) to lock into each respective Hook Socket on ICESA.

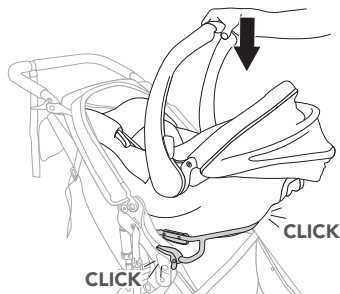

4. Verify Infant Car Seat is Securely Attached

Pull up on Infant Car Seat Carry Handle to verify Infant Car Seat is securely attached.

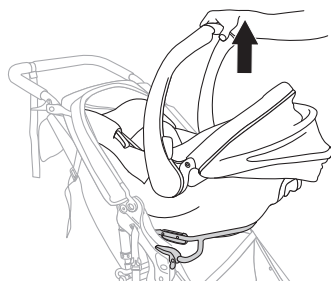

⚠️ WARNING

Failure to properly install Infant Car Seat on Infant Car Seat Adapter may result in accident, injury or death.

5. Secure Restraint Belt
Proceed to section titled "Secure Restraint Belt".

⚠️ WARNING

Failure to properly secure Restraint Belt may result in accident, injury or death.

⚠️ WARNING

Failure to properly install Infant Car Seat on Infant Car Seat Adapter may result in accident, injury or death.

5. Secure Restraint Belt

Proceed to section titled "Secure Restraint Belt".

⚠️ WARNING

Failure to properly secure Restraint Belt may result in accident, injury or death.

CHICCO®

INFANT CAR SEAT INSTALLATION

1. Prepare Stroller

Set parking brake, rotate canopy towards handlebar, place Restraint Belt ends to the sides of stroller seat. (See stroller owner's manual if necessary)

2. Align Infant Car Seat

Place Infant Car Seat "rear facing", directly centered on top of ICESA, align Shelf Feature on Infant Car Seat with Front Tube on ICESA.



⚠️ WARNING

Failure to properly secure Restraint Belt may result in accident, injury or death.

BRITAX®

INFANT CAR SEAT INSTALLATION

1. Prepare Stroller

Set parking brake, rotate canopy towards handlebar, place Restraint Belt ends to the sides of stroller seat. (See stroller owner's manual if necessary)

2. Align Infant Car Seat

Place Infant Car Seat "rear facing", directly centered on top of ICSA, align ICS Adapters on infant car seat with the Click & Go Receivers on ICSA.

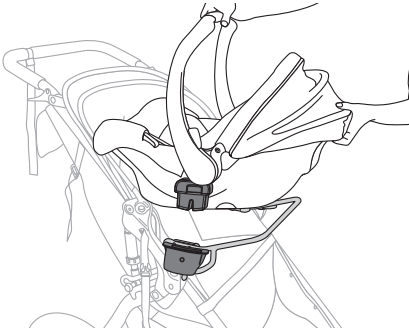

3. Verify Infant Car Seat Latched Properly

Push Infant Car Seat straight down onto ICSA until the adapters on each side lock into the receivers on ICSA.

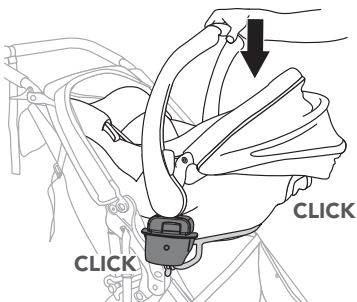

4. Verify Infant Car Seat Securely Attached

Lift up to ensure the infant car seat is secure.

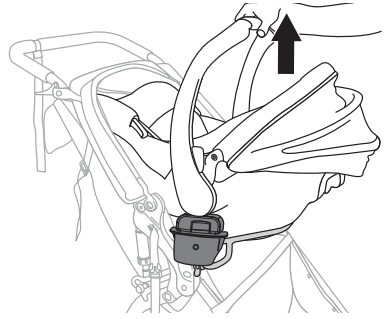

⚠️ WARNING

Failure to properly install Infant Car Seat on Infant Car Seat Adapter may result in accident, injury or death.

5. Secure Restraint Belt

Proceed to section titled "Secure Restraint Belt".

REMOVE INFANT CAR SEAT

1. Set Parking Brake

2. Remove Restraint Belt

3. Remove Infant Car Seat

Lift the Click & Go release buttons on each side and lift the infant car seat away from the ICSA.

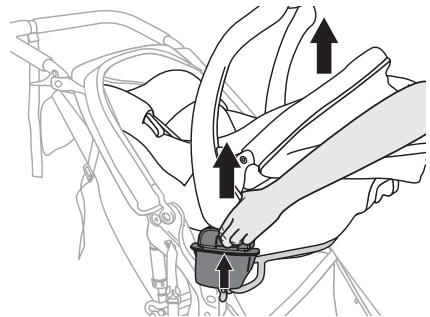

SECURE RESTRAINT BELT

1. Fasten Restraint Belt

Fasten restraint belt over Infant Car Seat securely.

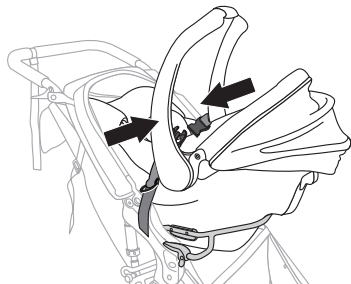

⚠️ WARNING

Failure to properly secure Restraint Belt may result in accident, injury or death.

2. Adjust Restraint Belt

Pull on Red Ring to tension Restraint Belt.

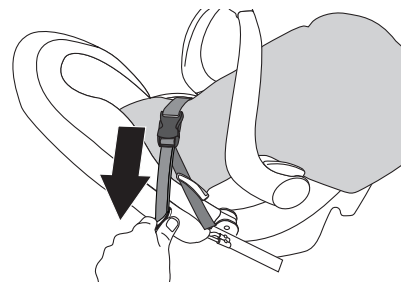

⚠️ WARNING

Be sure Restraint Belt tension is not constricting child as it may cause serious injury or death.

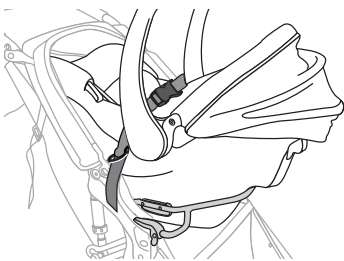

REMOVE INFANT CAR SEAT

FROM STROLLER

1. Prepare Stroller

Set parking brake, rotate canopy towards handlebar. (See stroller owner's manual if necessary).

2. Unfasten Restraint Belt

Unfasten buckle, place Restraint Belt ends to the sides of stroller seat.



3. Activate Release Handle

Activate Release Handle on Infant Car Seat then lift Infant Car Seat straight up and off stroller with Infant Car Seat Carry Handle.

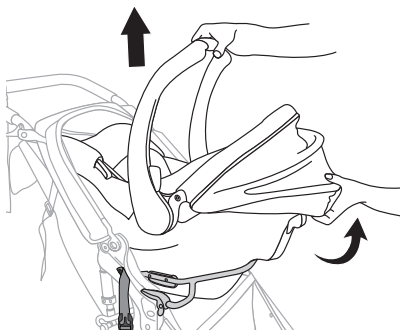

FOLDING STROLLER WITH

ICSA ATTACHED

⚠️ WARNING

Care must be taken when folding and unfolding the stroller to prevent finger entrapment or injury.

! WARNING

To avoid injuries, never fold or unfold stroller with other individuals within reach of stroller.

1. Set Parking Brake

Set parking brake. (See stroller owner's manual if necessary).

2. Unfasten Restraint Belt

Unfasten buckle, place Restraint Belt ends to sides of stroller seat.

3. Remove Infant Car Seat

Remove Infant Car Seat from ICESA and for Duallie strollers remove child from stroller seat.

4. Empty Stroller

Remove contents from low boy cargo basket and pockets.

5. Fold Handlebar

Squeeze both handlebar release levers simultaneously. (See stroller owner's manual if necessary).

6. Rotate Handlebar Forward

Slightly rotate handlebar towards seat and hold in place during next step.

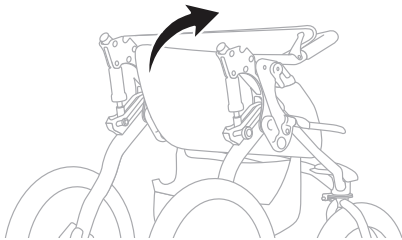

7. Lift Red Frame Release Handle

Using a short, quick tug, lift red frame release handle up. Keep tires on ground as stroller collapses toward front wheel. (See stroller owner's manual if necessary).

NOTE: We do not recommend leaving stroller folded with ICESA installed for long periods of time as it may leave an imprint in the stroller

seat. For long term folded storage, remove ICESA.

REMOVE ICESA FROM STROLLER

! WARNING

Remove Infant Car Seat Adapter and Restraint Belt when not in use.

! WARNING

Do not place children directly in the stroller seat with the Infant Car Seat Adapter installed. Remove Infant Car Seat Adapter from stroller prior to placing a child directly into the stroller seat.

! WARNING

Failure to follow these warnings may result in serious injury or death.

1. Prepare Stroller

Set parking brake, rotate canopy towards handlebar. (See stroller owner's manual if necessary).

NOTE: For illustrative purposes, Chicco compatible ICESA shown. Other ICESA single remove in same manner.

For Single Strollers Only

While holding down Red Release Buttons on both Accessory Adapters at sides of stroller, pull ICESA forward and out of Receiver Sockets, keeping alignment even, left to right, as you pull.

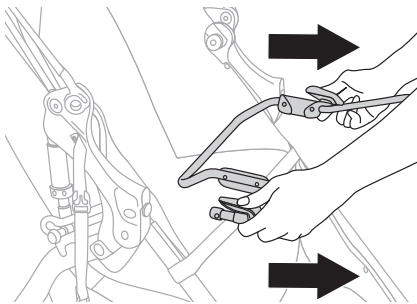

For Duallie Strollers Only

Slide Release Guard Door forward (towards you) prior to depressing Red Release Button. While holding down Red Release Buttons on both Accessory Adapters at sides of stroller, pull ICSA forward and out of Receiver Sockets, keeping alignment even, left to right, as you pull.

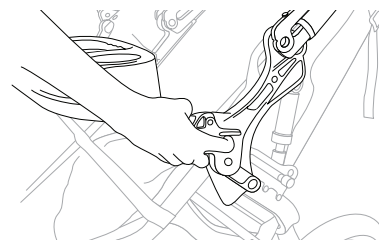

2. Slide Covers UP

Push to slide each Cover (at front of stroller Accessory Adapter) up on each side of stroller, covering each Receiver Socket.

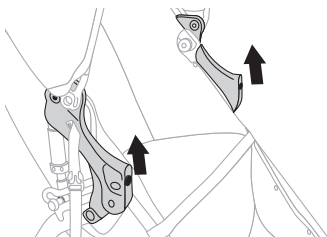

For Duallie Strollers Only

1. Release Canopy

Release right canopy stay from under Canopy Catch by pushing canopy down while pulling Catch up.

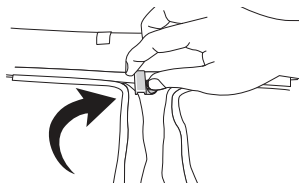

2. Rotate canopies

Rotate both canopies forward to expose Canopy Catch.

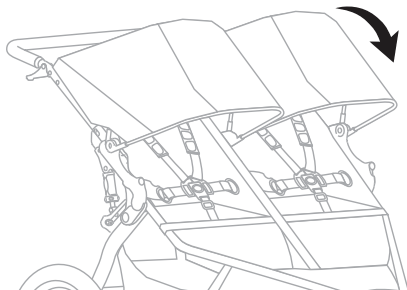

3. Unscrew canopy catch

Using a screwdriver, loosen screw on the Canopy Catch to release it from the cross strap webbing.

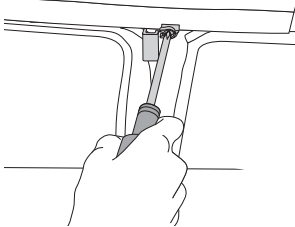

Do not attempt to disassemble canopy catch - it is designed to stay assembled even when screw is fully loosened.

4. Keep Canopy Catch

Keep Canopy Catch with Infant Car Seat Adapter for future use.

REMOVE RESTRAINT BELT FROM STROLLER

1. Unscrew Captured Screws

Using a screwdriver, unscrew each Captured Screw from each respective stroller Anchor Nut.

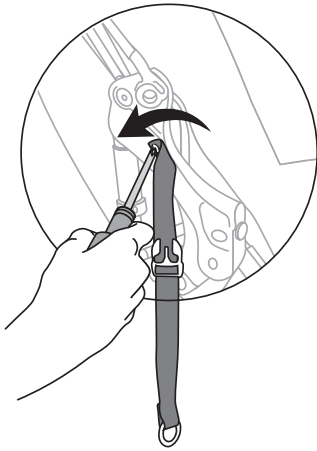

2. Keep Restraint Belt

Keep restraint belt together with ICESA for next use.

⚠ WARNING

Restraint Belt is intended for use with combination of BOB Infant Car Seat Adapter and compatible Infant Car Seats only. The Restraint Belt must be removed prior to using stroller without Infant Car Seat. Failure to remove Restraint Belt when not in use may result in accident, injury or death.

LIMITED WARRANTY

BOB Trailers, Inc. takes pride in its workmanship and strives to manufacture the best products possible. Therefore, we warranty our Infant Car Seat Adapter against defects in material and workmanship for the periods and parts set forth below, subject to the conditions listed below. Since no product is indestructible, it does not cover defects attributable to or resulting from normal wear, abuse or alteration.

- The ICESA is warranted for one year from the date of original purchase.
- Warranty is only valid for the original purchaser.

- Proof of purchase is required to exercise this warranty.
- Labor and freight charges are not included.
- Normal wear, neglect, abuse, accidents, improper assembly, maintenance, or the installation of parts or accessories not compatible with original intended use of the ICESA as sold, are not covered by this warranty.

WARRANTY CLAIMS

Warranty claims must be made through an authorized dealer.

This warranty is limited to the repair or replacement of the defective part.

BOB Trailers, Inc. shall in no event be responsible for consequential or special damages.

This limited warranty is the only express or implied warranty applicable to BOB. Any implied warranties, including warranties of merchantability and fitness shall be limited in scope and duration in accordance with this limited warranty.

Copyright © 2011 BOB Trailers, Inc.

BOB TRAILERS, Inc.

(800) 893-2447

www.bobgear.com

